

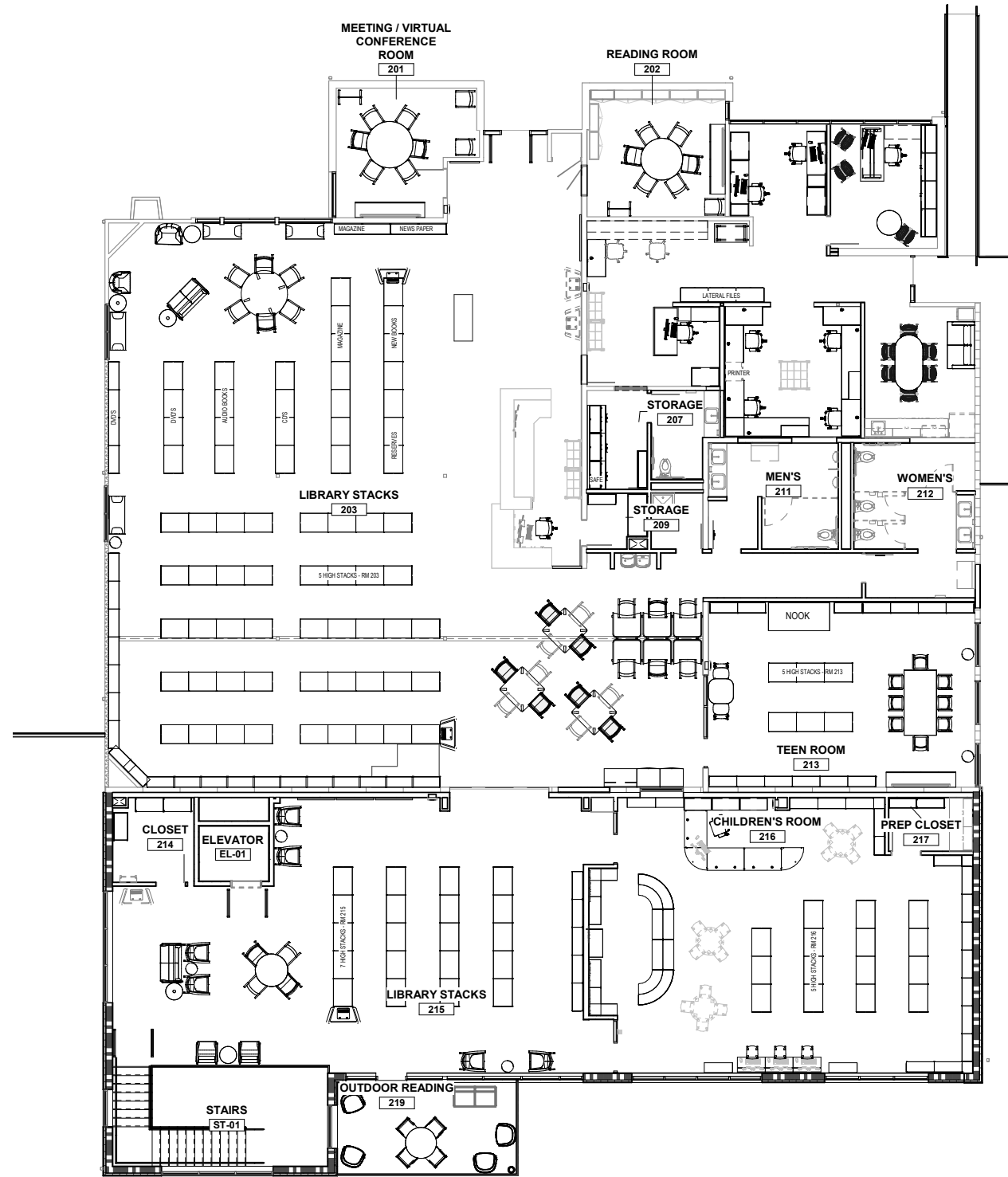

CITY OF SIERRA MADRE LIBRARY

Furniture & Finishes Visual Index

FLOOR PLANS



Level 1

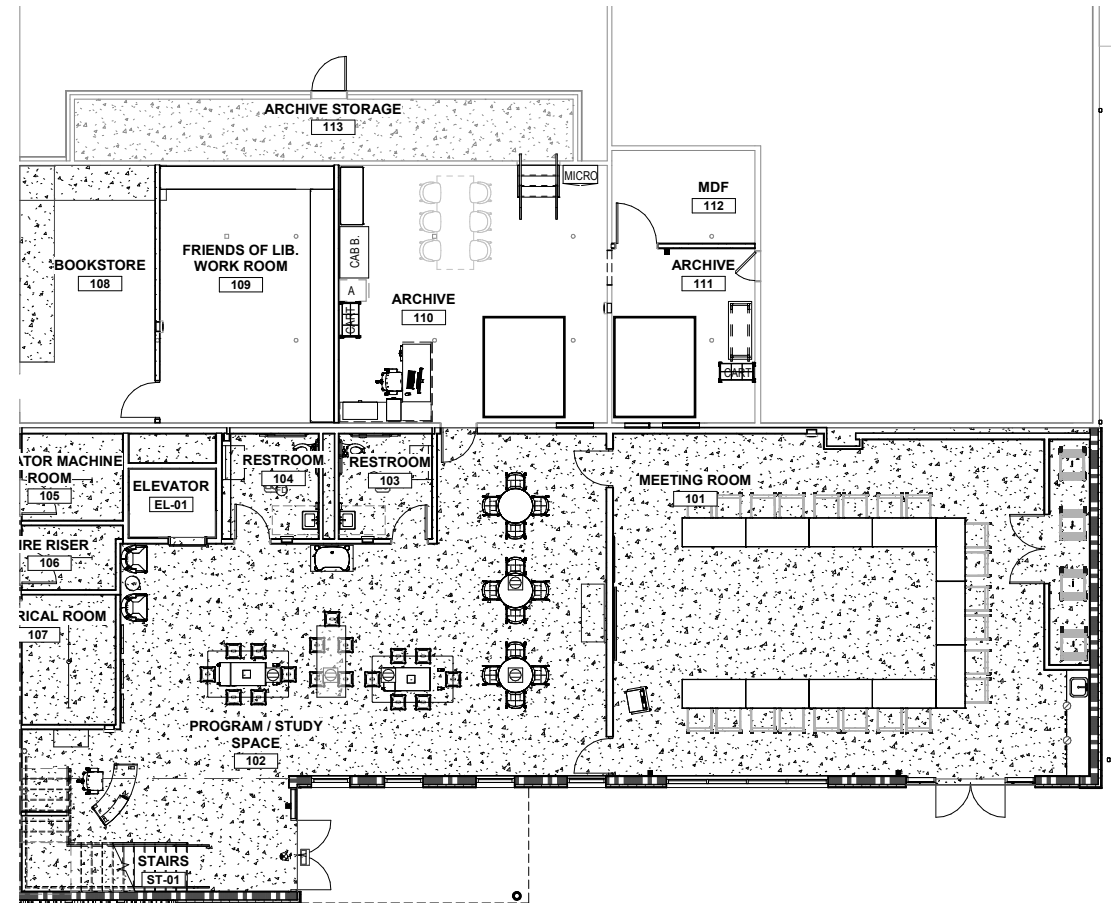

Level 0



MAIN CIRCULATION DESK ENTRY

A CUSTOM BULLETIN BOARD

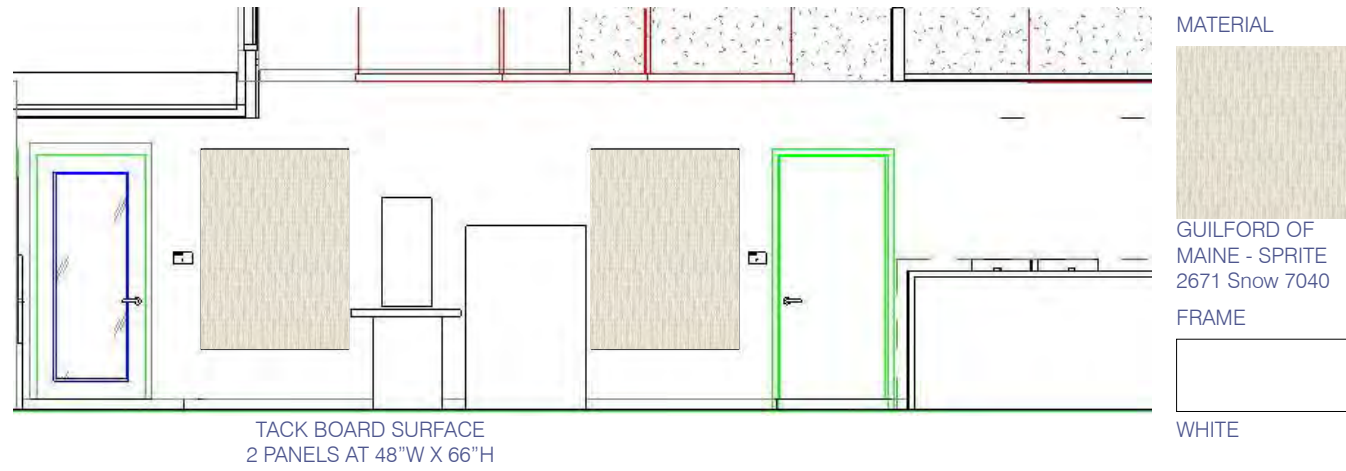

MATERIAL
 GUILFORD OF MAINE - SPRITE 2671 Snow 7040
 FRAME
 WHITE

B BULLETIN BOARD



PETER PEPPER WOOD FRAMED BULLETIN/TACK SURFACE - NATURAL CORK
 WBCWGL3636 - 36"W x 36"H
 LINEAR EDGE

C BULLETIN BOARD



DISPLAYS 2 GO WALL MOUNTED ADJ POCKETS
 2RP9CLR
 29"W X 23"H

D OUT DOOR BULLETIN BOARD

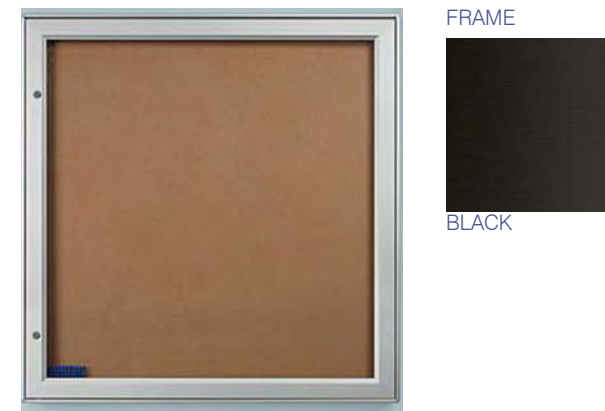

DISPLAYS 2 GO ENCLOSED BULLETIN BOARD FOR OUTDOOR USE WITH LOCKING DOOR - SILVER ODNBC-B12A4
 41"X42"

- E EXISTING TECH: SELF CHECKOUT
- F EXISTING TECH: LAP TOP CHECKOUT

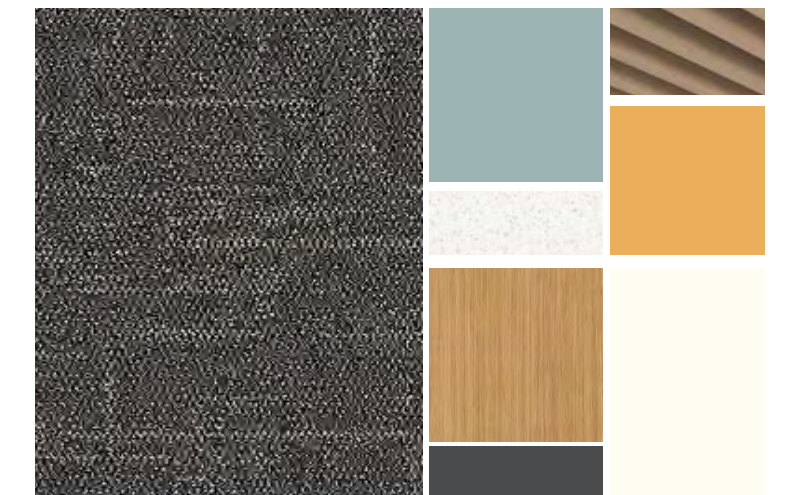
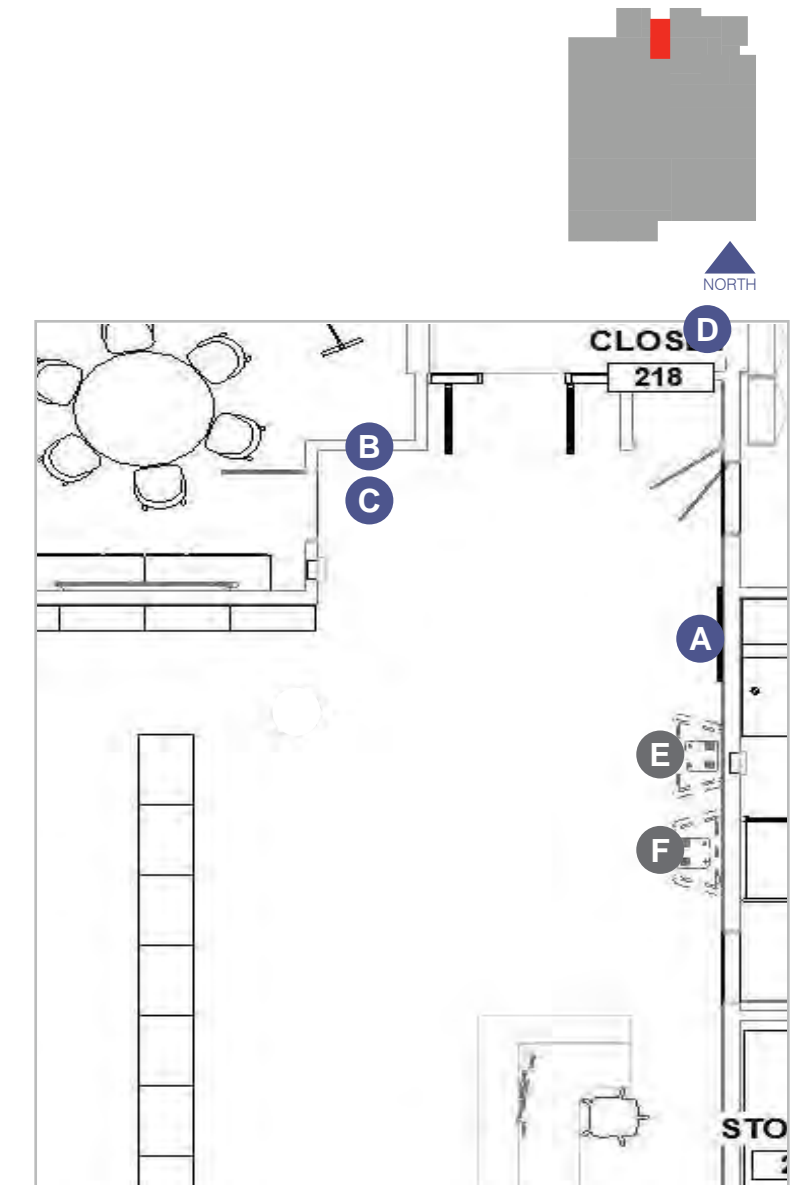

STAFF TASK CHAIRS



A HUMANSCALE - FREEDOM

ERGONOMIC & WEIGHT SENSITIVE RECLINE AND SYN-
CHRONOUSLY ADJUSTABLE ARMRESTS
WC 400LB, 15YR WARRANTY



B HUMANSCALE - FREEDOM STOOL

ERGONOMIC & WEIGHT SENSITIVE RECLINE AND SYN-
CHRONOUSLY ADJUSTABLE ARMRESTS
WC 400LB, 15YR WARRANTY

UPHOLSTERY



LOTUS PLUM

FRAME

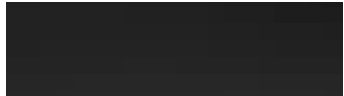

GRAPHITE

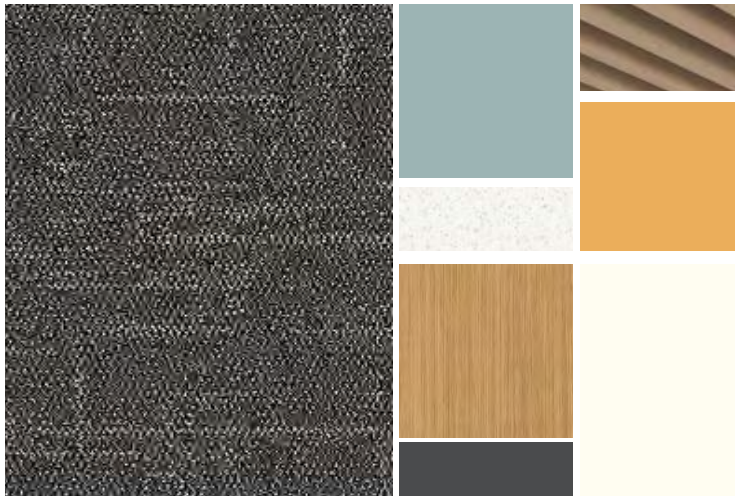
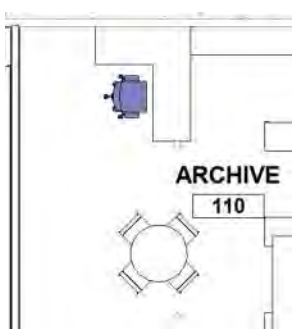
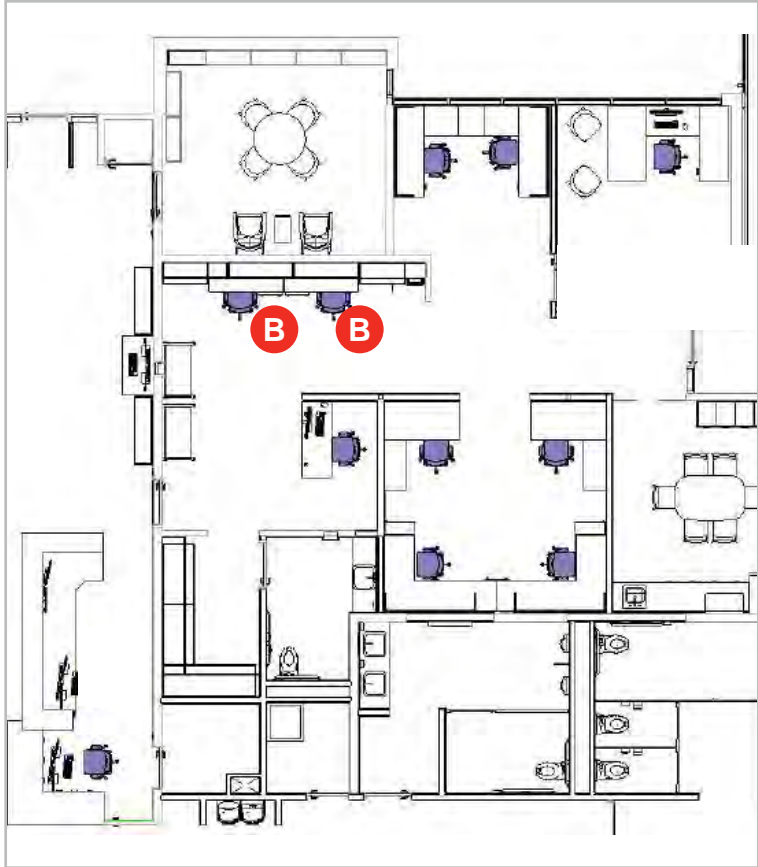

LIBRARY STACKS

PRODUCT LOCATIONS

- 1** STACKS
 - FLUSH CLOSED BASE
 - SLIDING DIVDERS
 - WOOD PANEL ENDS ON ALL STACKS
- 2** -STANDING END COUNTERS FOR BOOK SEARCH LAP TOPS
- A** NEWSPAPER
 - 10 NEWSPAPER RODS
 - SHLEIVING FOR 10 NEWSPAPER BACK STOCK
- B** MAGAZINE RACK
 - 50 PUBLICATIONS
 - PRINCETON FILE BOX WITH SLOPING SHELF WITH ENCLOSED STORAGE
- C** DISPLAY CASE
 - BATTERY PWR LIGHT
- D** DVD
 - COUNT 2236 ADULT + 764 CHILDRENS
 - UPPER SHELVES WITH DISPLAY SHELF
 - BOTTOM SHELVES WITH PULL OUT METAL BROWSING BOX
- E** AUDIO BOOKS
 - COUNT 973
 - MIN 120 LINEAR FT
- F** CD'S
 - COUNT 1009-
 - UPPER SHELVES WITH DISPLAY SHELF
 - BOTTOM SHELVES WITH PULL OUT METAL BROWSING BOX
- G** NEW BOOKS
- H** RESERVES
- I** LIBRARY THINGS: HOOKS FOR MISC. + BACKPACKS

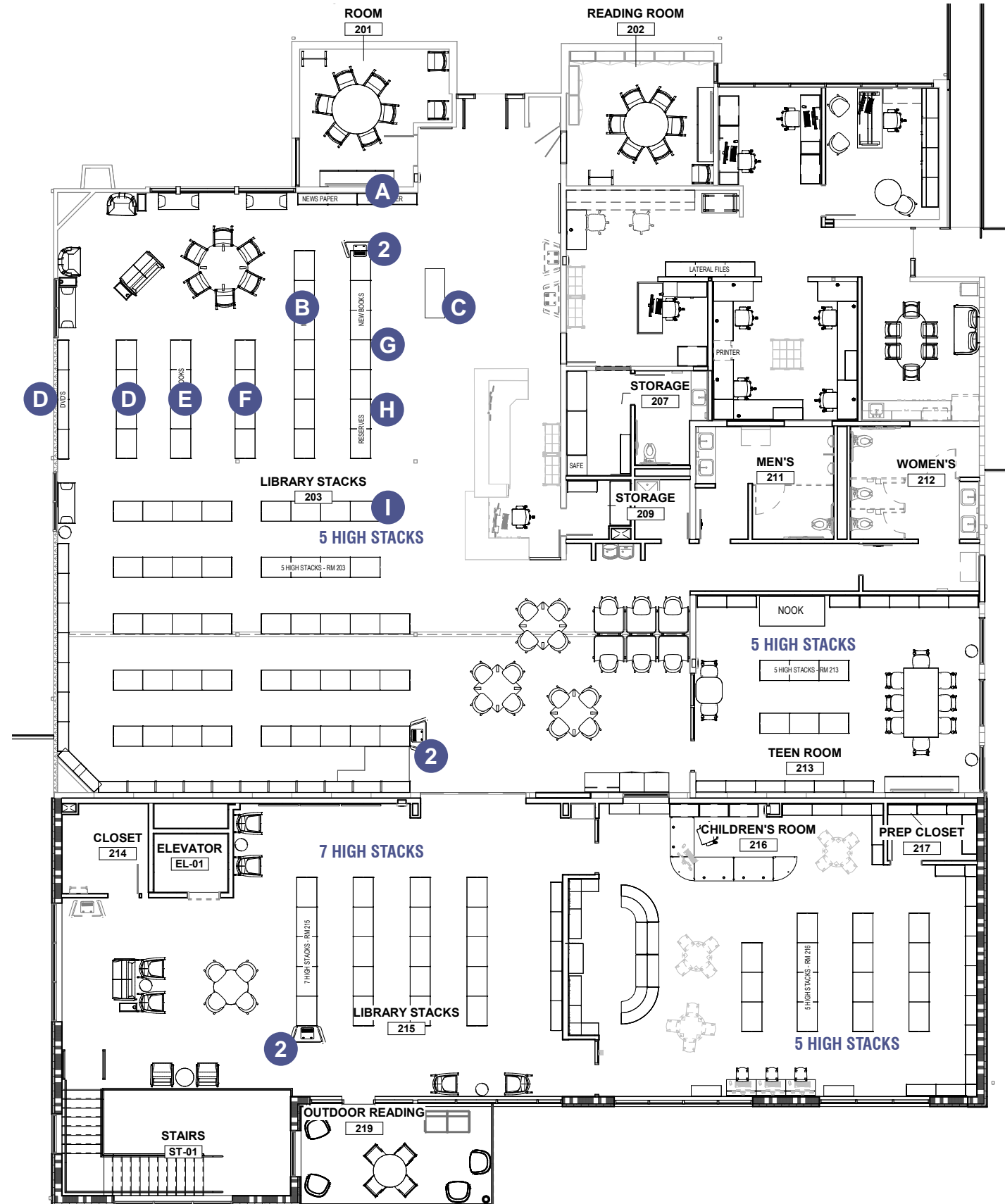

METAL SHELVING



SOFT WHITE

END PANELS



NATURAL RIFT

INTEGRAL BACK SHELF WITH SLIDING WIRE DIVDER

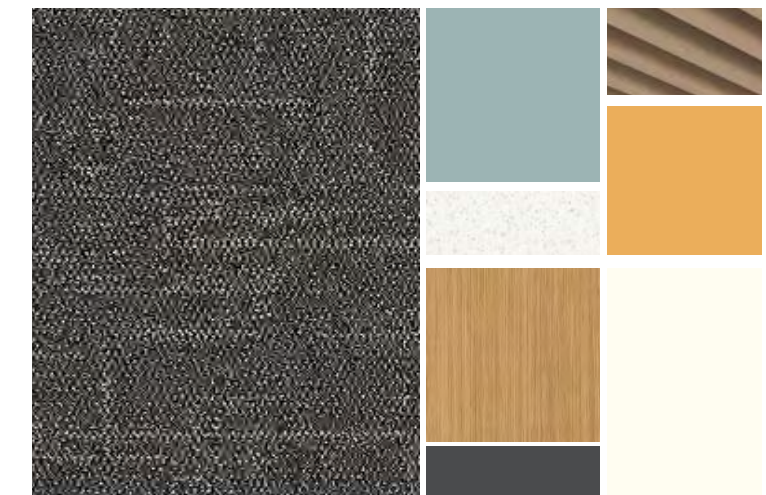

LIBRARY STACKS

PRODUCT LOCATIONS

- 2** -STANDING END COUNTERS FOR BOOK SEARCH
LAP TOPS
- MANHATTAN BEACH
- DOOR WITH LOCK

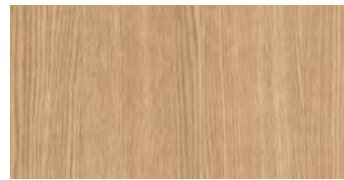

NATURAL RIFT

- A** NEWSPAPER
-10 NEWSPAPER
-SHLEIVING FOR 10 NEWSPAPER BACK STOCK

- B** MAGAZINE RACK
-50 PUBLICATIONS



PERIODICAL DISPLAY UNIT FOR MAGAZINES & NEWSPAPERS

- D** DVD
- COUNT 2236 ADULT + 764 CHILDRENS
- UPPER SHELVES WITH DISPLAY SHELF
- BOTTOM SHELVES WITH PULL OUT METAL BROWSING BOX

- E** AUDIO BOOKS
-COUNT 973
-MIN 120 LINEAR FT

- F** CD'S
-COUNT 1009-
-UPPER SHELVES WITH DISPLAY SHELF
-LOWER SHELVES WITH PULL OUT METAL BROWSING BOX



MULTIPURPOSE DIVDER ADJUSTABLE SHELF



PULLOUT BROWSING BOX BASE SHELF

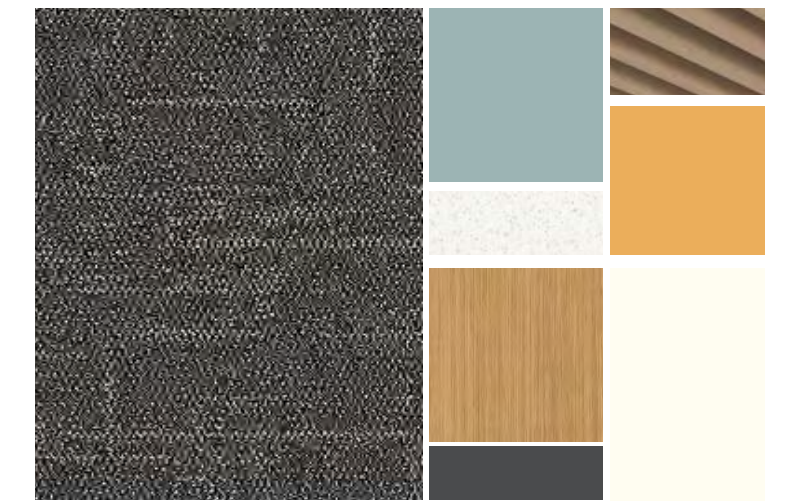

MEETING & VIRTUAL CONFERENCE 201

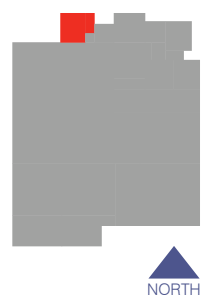

A TABLE OPTION
*TOP & BASE TO MATCH



C CREDENZA
*TO MATCH CONFERENCE TABLE



B

(6) DINING UPH SEAT
& BACK + ARMS



(2) GUEST UPH SEAT
& BACK - NO ARMS

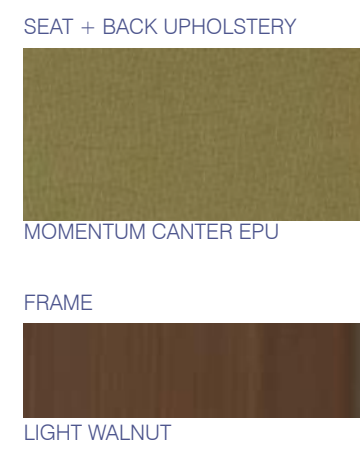

KWALU CATERINA DINING + GUEST
FRAMES ARE MOISTURE IMPERVIOUS
GRAFFITI- RESISTANT, STEEL REINFORCED
325lb W.C.

D MOBILE MARKER BOARD

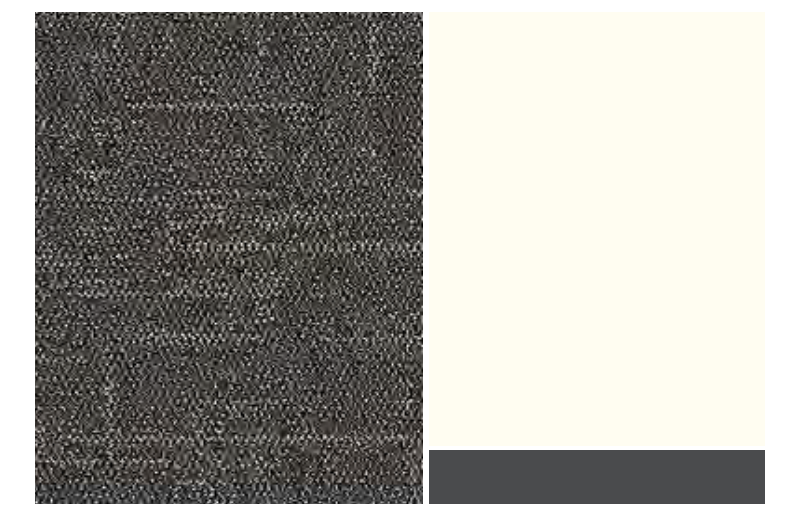
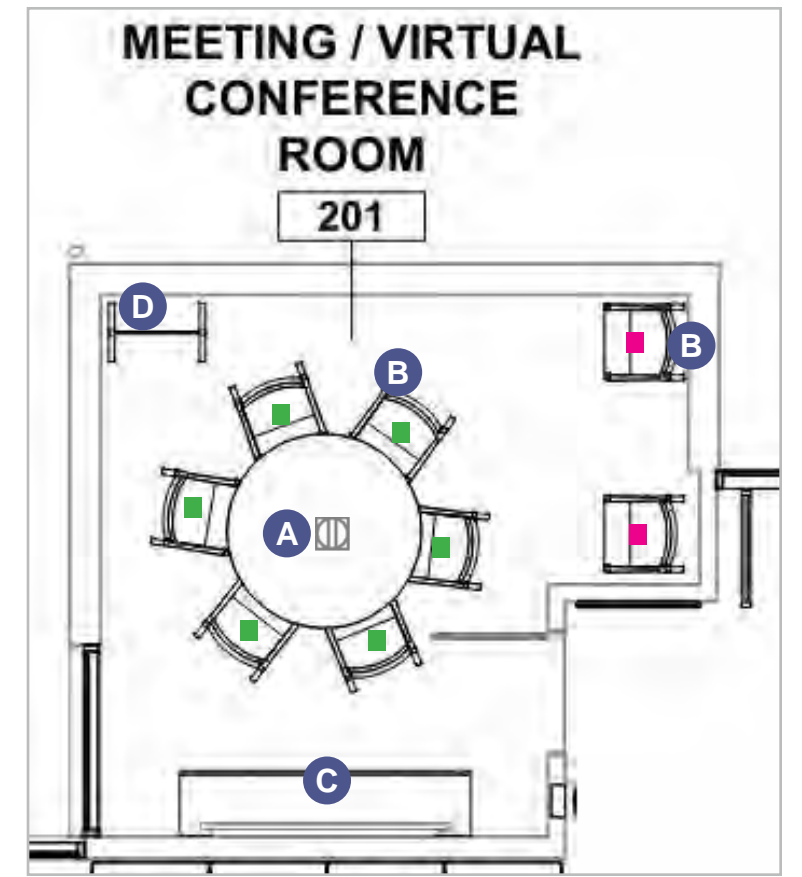

FIREPLACE LOUNGE

D SIDE TABLE + PWR



KWALU BRIANZA + POWER

E SIDE TABLE



KWALU PALENCIA

SOLID SURFACE



NUBLADO



LIGHT WALNUT

POWER



BLACK

F TABLE



ROUND TOP



JSI BOURNE ROUND TOP
VENEER OR LAMINATE TOP WOOD FRAME
60" ROUND + POWER CENTER"

FRAME



HPL UMBER

POWER



BLACK

G POWER TABLE



PAINT



CARBON GREY

KI LAYER POWER TOWER
6 TAMPER RESISTANT POWER RECEPTACLES
(3 PER SIDE) - 2 USB A, 2 USB C

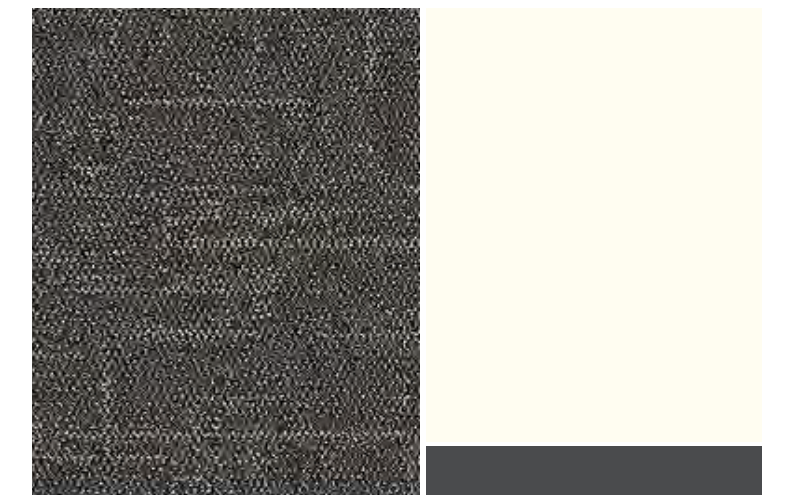
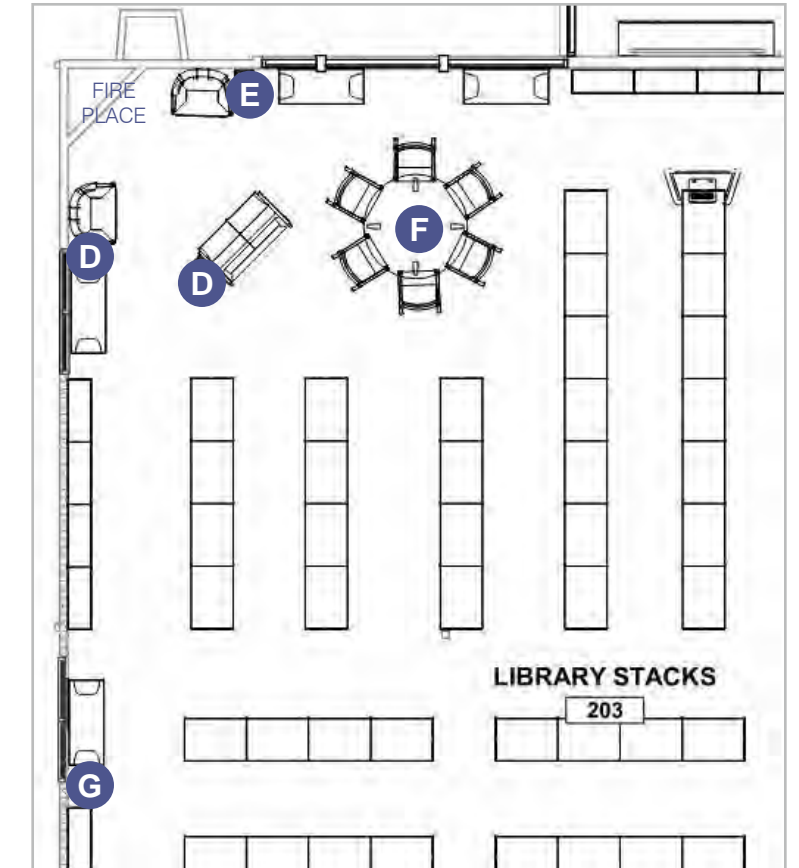
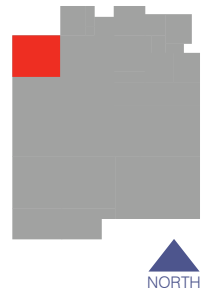

READING ROOM 202

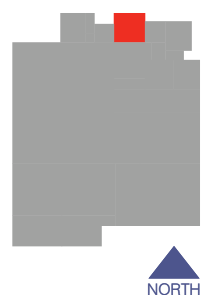

A TABLE OPTION
*TOP & BASE TO MATCH



JSI ANTHOLOGY CONE BASE TABLE
60" ROUND TOP

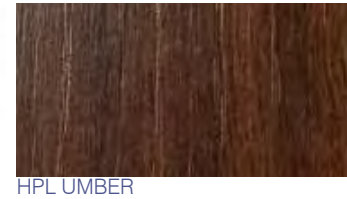

C CREDENZA
*TO MATCH CONFERENCE TABLE



JSI ANTHOLOGY CONFERENCE CREDENZA
ON INSET METAL BASE 29"H x 90"W x 20"D TOUCH LATCH,
LOCKING

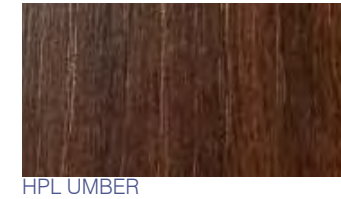

LEGS



B

(6) DINING UPH SEAT
& BACK + ARMS



(1) GUEST UPH SEAT
& BACK - NO ARMS



SEAT + BACK UPHOLSTERY

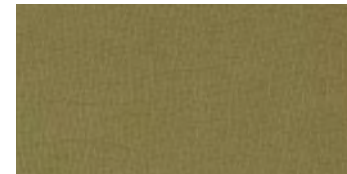

FRAME



KWALU CATERINA DINING + GUEST
FRAMES ARE MOISTURE IMPERVIOUS
GRAFFITI- RESISTANT, STEEL REINFORCED
325lb W.C.

D MOBILE MARKER BOARD



MOORE CO. INKLUD MOBILE BOARD

FRAME:



DOUBLE SIDED
MAGNETIC PORCELAIN
STEEL SURFACE
WITH CUP

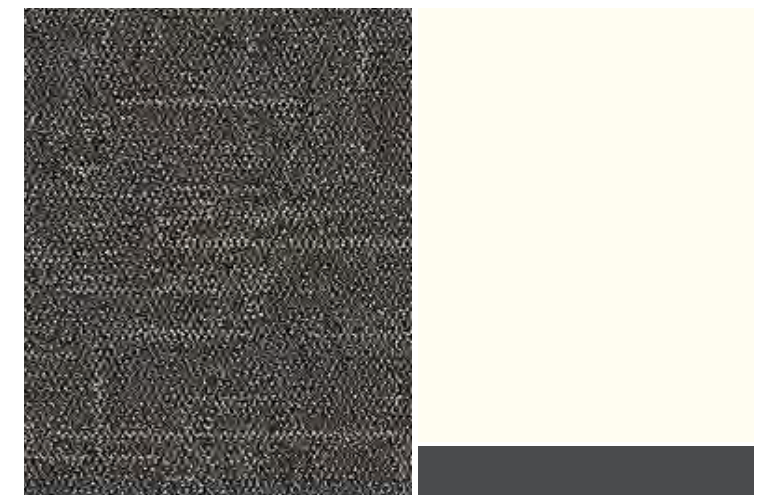
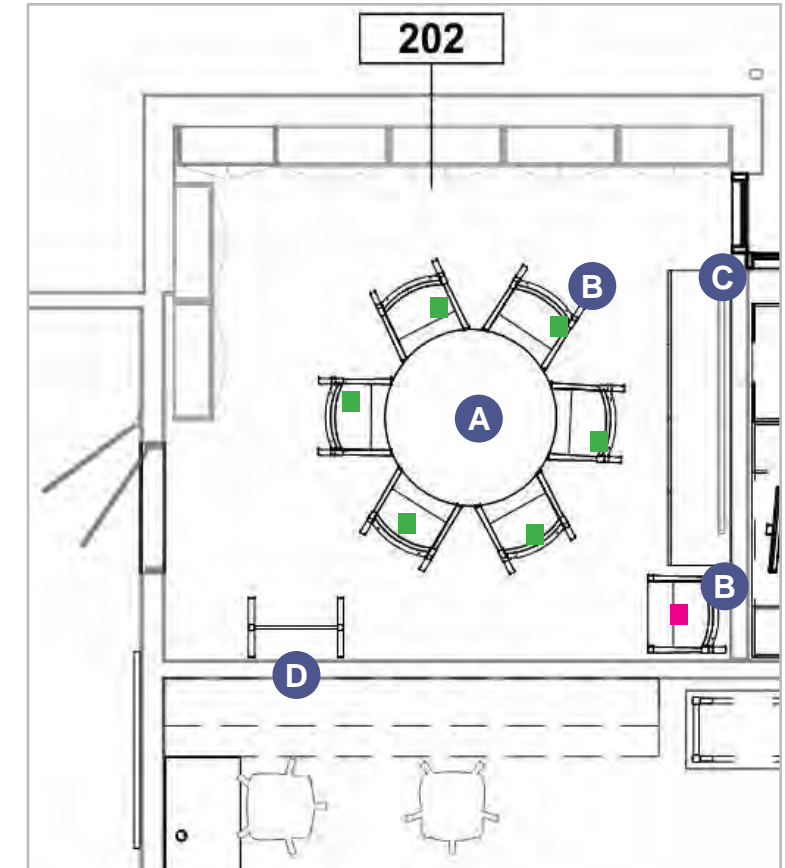

FIREPLACE LOUNGE

A LOUNGE SEATING OPTIONS



KWALU MONTEDORO B. LOUNGE
30"W SEAT, 525LB W.C.
CONCEALED CLEAN OUT

BACK:

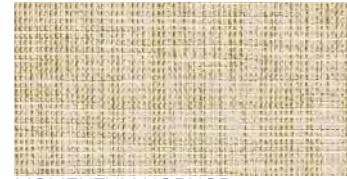

MOMENTUM HOBNOB
GINGER

SEAT



MOMENTUM CORDOVAN EPU
ACORN

FRAME



LIGHT WALNUT

C SETTEE SEATING



KWALU MODERNA LOVE SEAT
41"W SEAT, 525LB W.C.
VISIBLE CLEAN OUT, STEEL REINFORCED
+ SOLID SURFACE ARM CAPS

BACK:

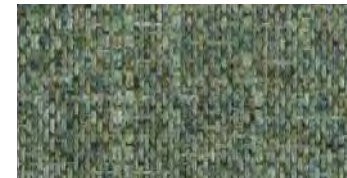

MOMENTUM WILLA LAWN

SEAT



MOMENTUM CORDOVAN EPU
ALABASTER

FRAME



LIGHT WALNUT

B BENCH SEATING



KWALU POTENZA BENCH
STEEL REINFORCED



STINSON FUSE 2.0 NUGGET

FRAME



LIGHT WALNUT

F GUEST CHAIR

- (2) UPH SEAT + ARMS
- (4) UPH SEAT - NO ARMS



KWALU CATERINA CAFE
FRAMES ARE MOISTURE IMPERVIOUS
GRAFFITI- RESISTANT, STEEL REINFORCED, 18.25"SW
(4) ARMS (4) NO ARMS 325lb W.C.

SEAT UPHOLSTERY



MOMENTUM CANTER EDU
VARDITE

FRAME



LIGHT WALNUT

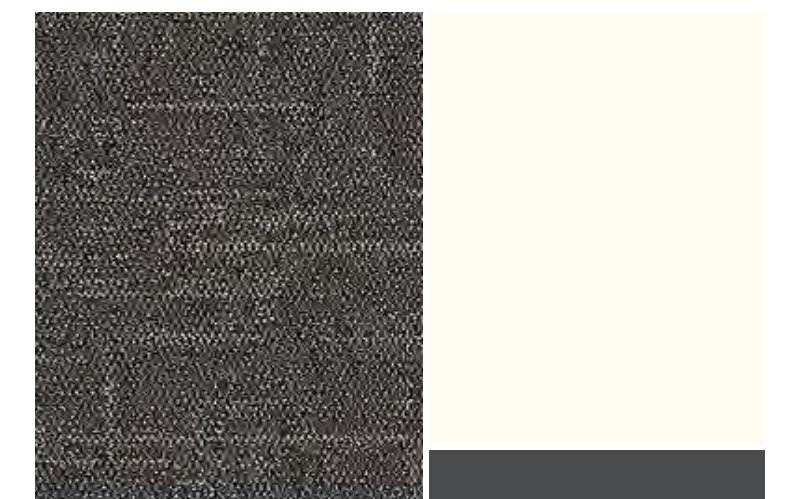
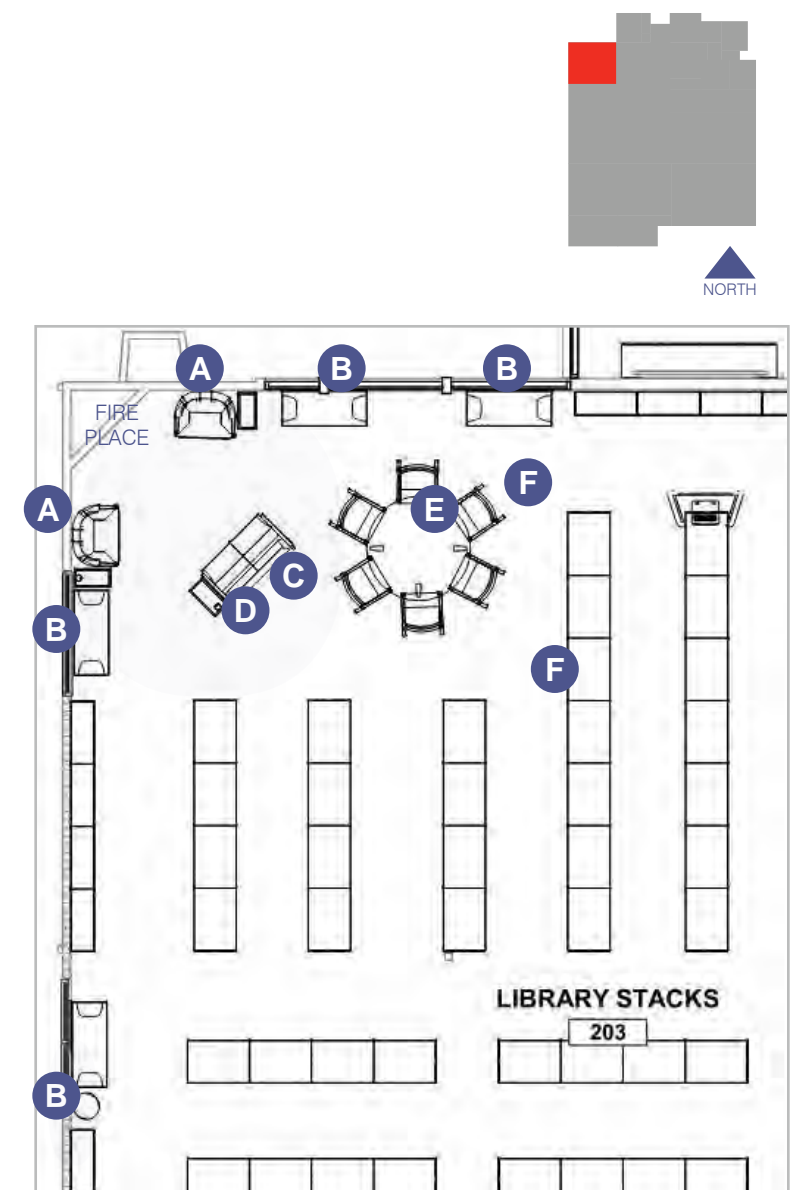

TEEN ENTRY

A TABLE



JSI BOURNE SQUARE TOP
VENEER OR SOLID SURFACE TOP WOOD FRAME
42" X 42"

FRAME

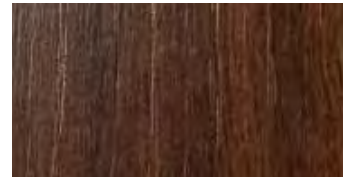

HPL UMBER

POWER



BLACK

C DESK POD



JSI CAAV DESK POD
WOOD LEGS LAMINATE SURFACE + CENTER
POWER WITH 2 USB-A

FABRIC SCREEN



MOMENTUM CARAVAN SHADOW

WOOD LEGS & HPL TOP



UMBER

POWER



BLACK

B CHAIR TYPES

- (2) GUEST SLAT BACK UPH SEAT + NO ARMS
- (4) DINING SLAT BACK UPH SEAT + ARMS
- (4) GUEST UPH SEAT & BACK + NO ARMS
- (8) DINING UPH SEAT & BACK + ARMS



KWALU CATERINA GUEST & DINING
FRAMES ARE MOISTURE IMPERVIOUS
GRAFFITI- RESISTANT, STEEL REINFORCED, 18.25"SW
325lb W.C.

SEAT UPHOLSTERY



MOMENTUM CENTER EDU
VARDITE

FRAME



LIGHT WALNUT

D PRINTER STATION



FLEETWOOD ILLUSION STORAGE DESK + HINGED DOORS +
BACK SPLASH + ALL LOCKABLE STORAGE
102"W X 24"D X 30"H

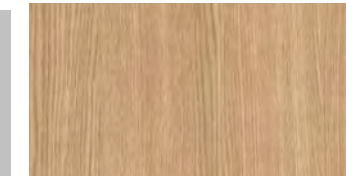

NATURAL RIFT

PULLS



BLACK

OPTION 1: LOUNGE + TABLES

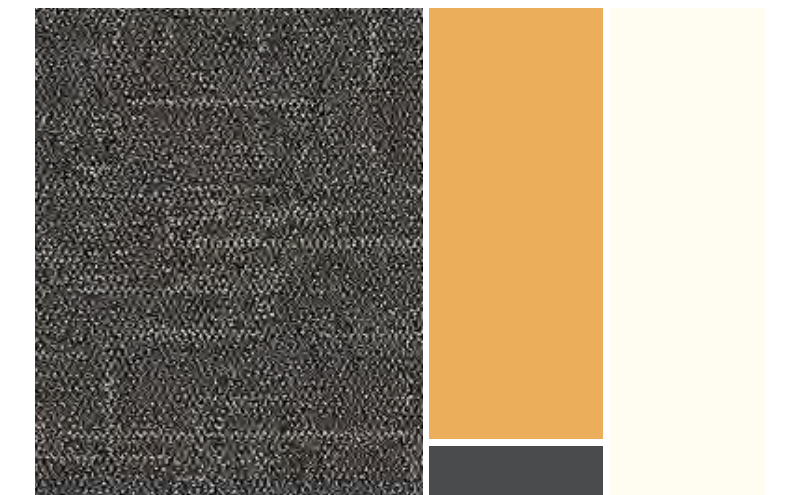
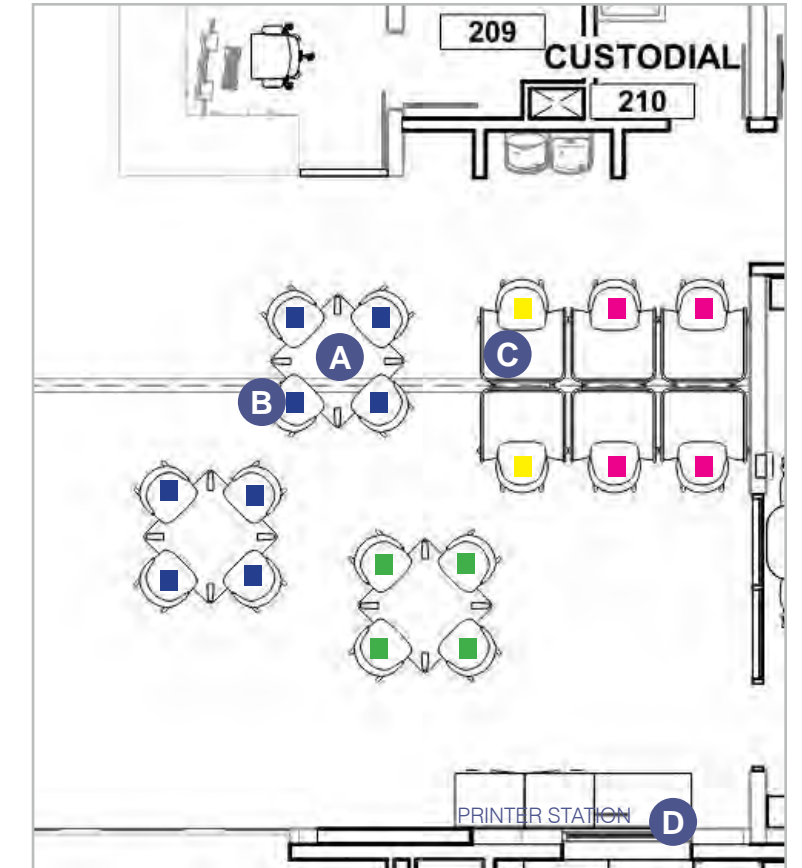

TEEN ROOM

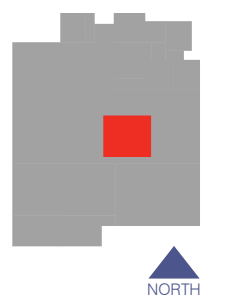

A GAME TABLE CHAIR



HAG CELJ CHAIR
STACKS 12H, UPH AVAIL.
WC: 300LBS, LIMITED LIFETIME
NO ARMS

B GAME TABLE



JSI ANTHOLOGY
SOFT RECTANGLE WITH EASDED EDGE
+ OBLIQUE LEG
42"D X 84"W

C CREDENZA



JSI ANTHOLOGY CONFERENCE CREDENZA
ON INSET METAL BASE 29"H x 90"W x 22"D TOUCH LATCH,
LOCKING

D POWER TABLE



KI LAYER POWER TOWER
6 TAMPER RESISTANT POWER RECEPTACLES
(3 PER SIDE) - 2 USB A, 2 USB C

E NOOK



NOOK HUDDLE
78"W X 30.3D X 77"H
REAR MARKER BOARD + DESK TOP POWER

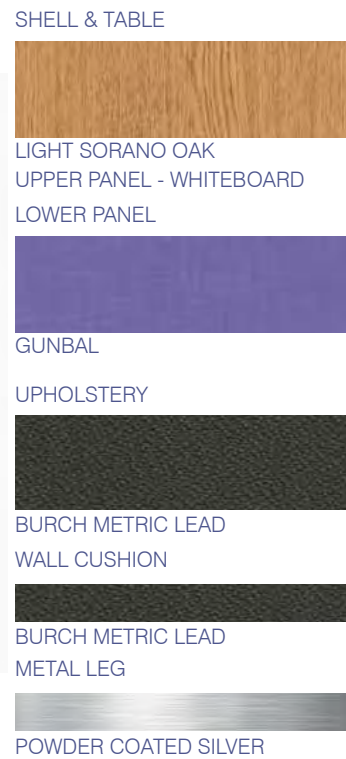

F GUEST TABLE



ENCORE HADO SQUARE
TOP 36X36

G GUEST CHAIR



ENCORE SUNNY

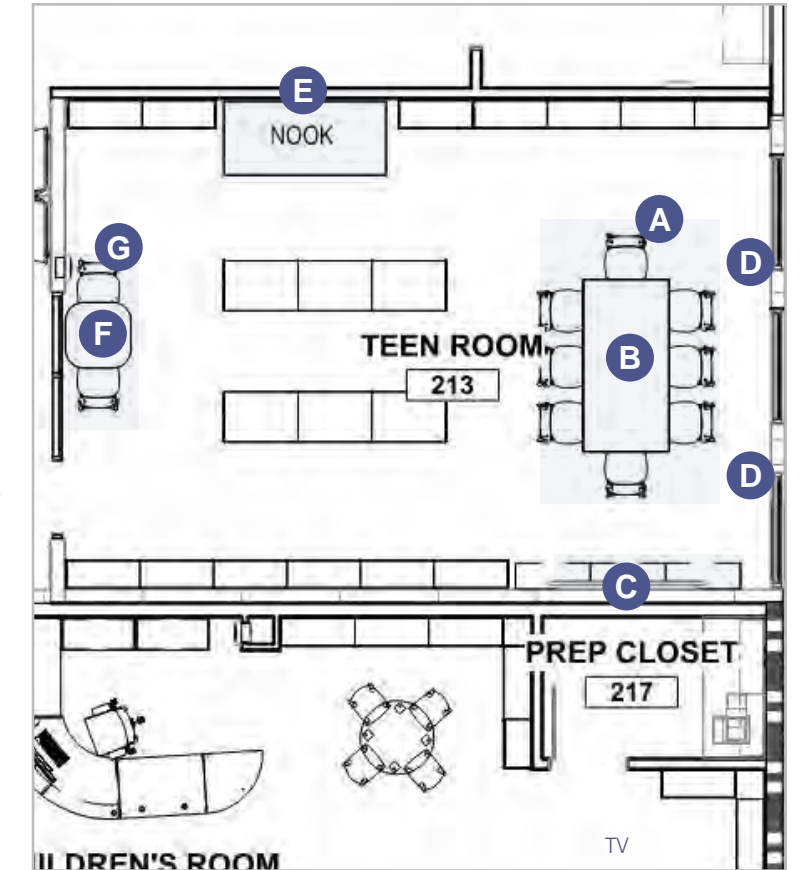

VIEW FROM TOP OF STAIR

A



KWALU MODERNA LOUNGE
30"W SEAT, 525LB W.C.
VISIBLE CLEAN OUT

FULL UPHOLSTERED



MOMENTUM CORDOVAN EPU
ACORN

FRAME



LIGHT WALNUT

D SETTEE SEATING



KWALU MODERNA LOVE SEAT
41"W SEAT, 525LB W.C.
VISIBLE CLEAN OUT, STEEL REINFORCED
+ SOLID SURFACE ARM CAPS

BACK:

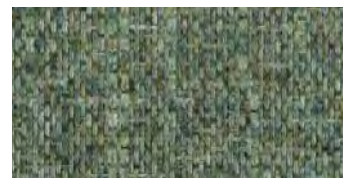

MOMENTUM WILLA LAWN

SEAT



MOMENTUM CORDOVAN EPU
ALABASTER

FRAME



LIGHT WALNUT

B

BACK:

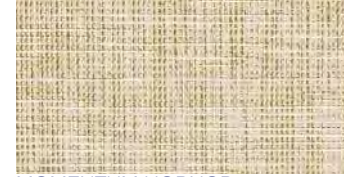

MOMENTUM HOBNOB
GINGER

SEAT



MOMENTUM CORDOVAN EPU
ACORN

FRAME



LIGHT WALNUT

C

BACK:



MOMENTUM WILLA BLUE MOON

SEAT



MOMENTUM SILICA SUEDE
INDIGO

FRAME



LIGHT WALNUT

E GUEST CHAIR

(2) UPH SEAT + ARMS
(2) UPH SEAT - NO ARMS



KWALU CATERINA CAFE
FRAMES ARE MOISTURE IMPERVIOUS
GRAFFITI- RESISTANT, STEEL REINFORCED, 18.25"SW
325lb W.C.

SEAT UPHOLSTERY



MOMENTUM CANTER EDU
VARDITE

FRAME



LIGHT WALNUT

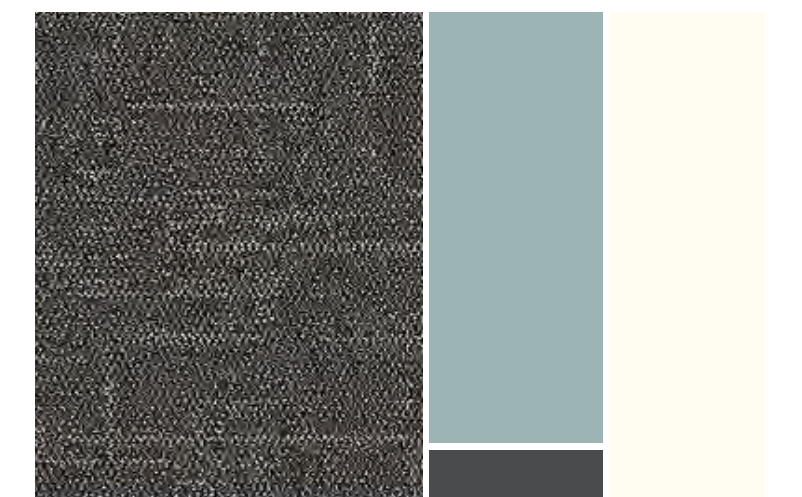
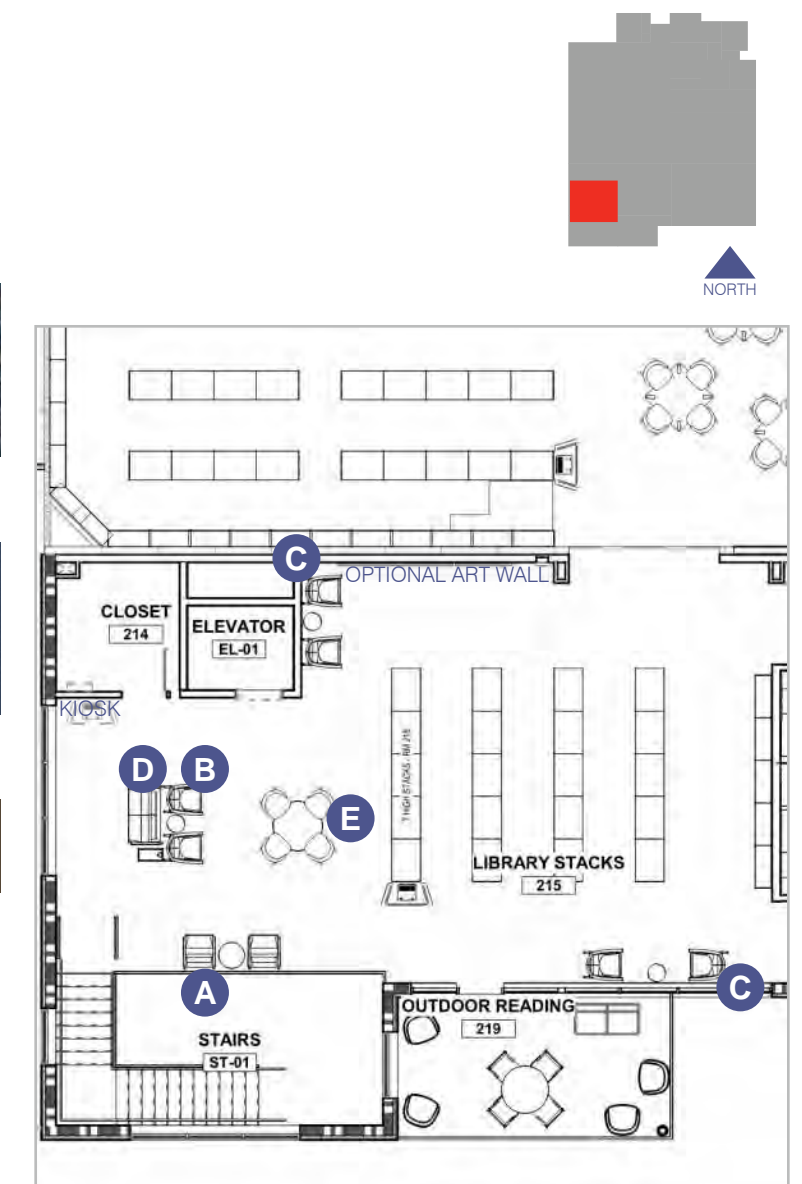

LIBRARY STACKS 215

E NOOK



NOOK HUDDLE
78"W X 36D X 77"H
REAR MARKER BOARD + DESK TOP POWER

SHELL



LIGHT SORANO OAK

BACK PANEL



FIBER OPTIC TWINKLE CARPET

UPHOLSTERY



BURCH METRIC LEAD
WALL CUSHION



BURCH METRIC LEAD

G GUEST CHAIR



ENCORE SUNNY

BACK:



MOMENTUM WILLA BLUE MOON
SEAT



MOMENTUM SILICA SUEDE
INDIGO

CHAIR ACCENTS



METALLIC SILVER

LEGS + TOP



SABLE ASH

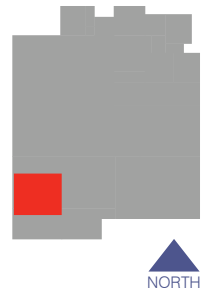

NORTH

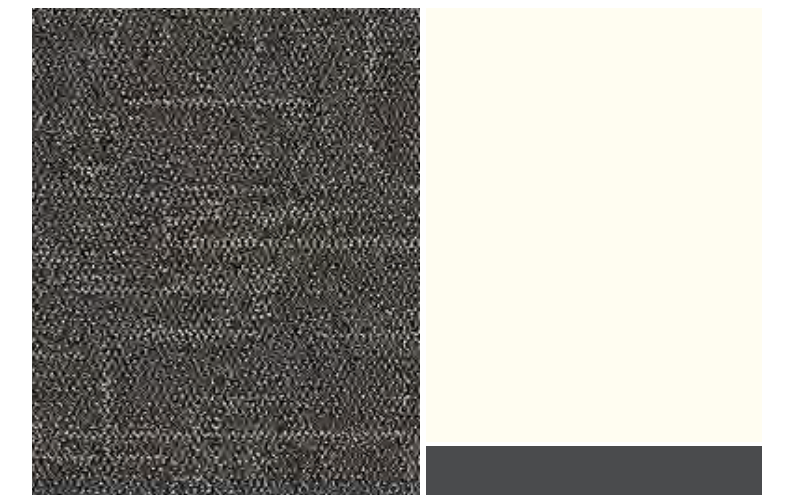
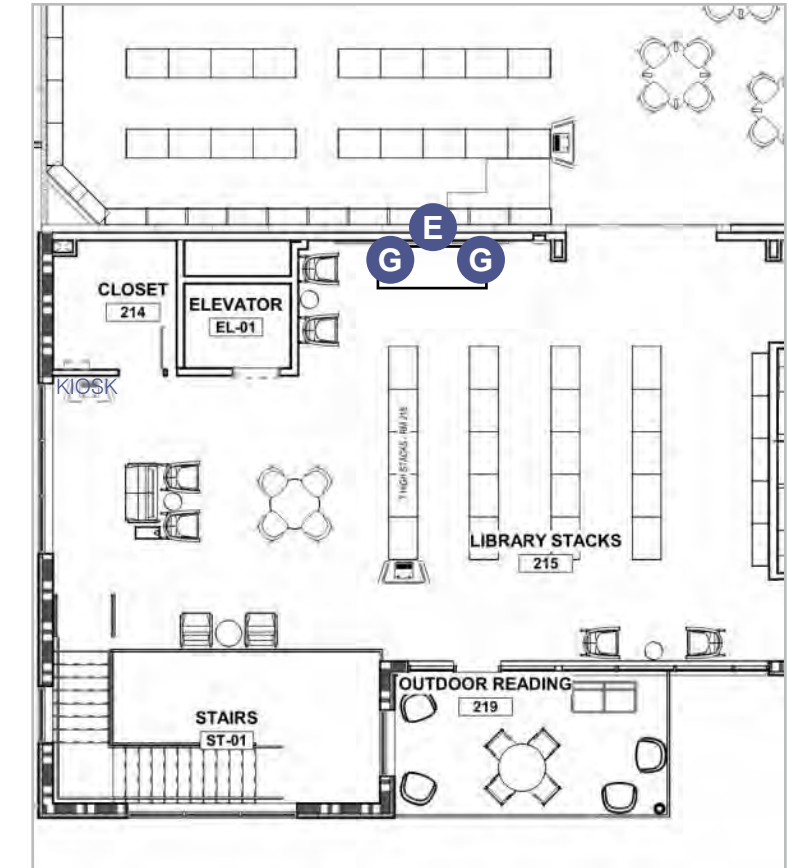

VIEW FROM TOP OF STAIR

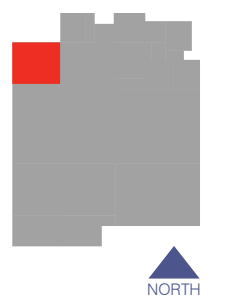

D SIDE TABLE + PWR



KWALU BRIANZA + POWER

E SIDE TABLE



KWALU PALENCIA

SOLID SURFACE



NUBLADO



NORTHERN WALNUT

POWER



BLACK

E TABLE



ROUND TOP



JSI BOURNE ROUND TOP
VENEER OR LAMINATE TOP WOOD FRAME
60" ROUND + POWER CENTER

FRAME



HPL UMBER

POWER



BLACK

G POWER TABLE



PAINT



CARBON GREY

KI LAYER POWER TOWER
6 TAMPER RESISTANT POWER RECEPTACLES
(3 PER SIDE) - 2 USB A, 2 USB C

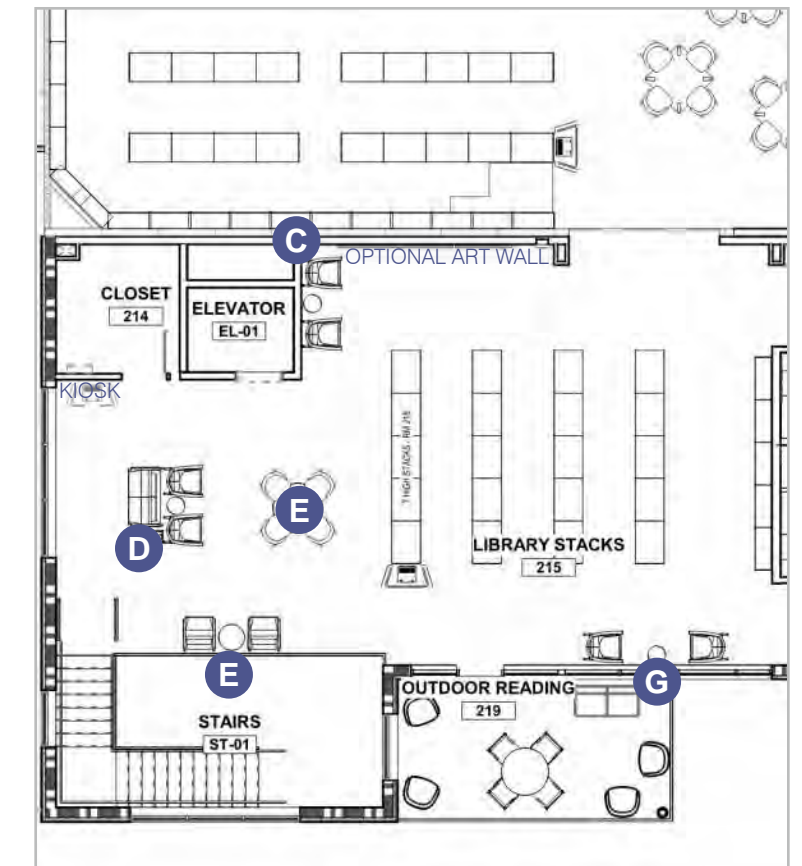

CHILDREN'S ROOM

A STORY TIME CENTER



TMC GROVE BENCH
MODIFIED TO SIT FLUSH AGAINST BACK WALL

WOOD FINISH

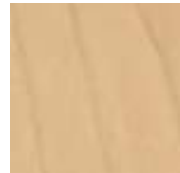

CLEAR

SEAT



MOMENTUM TRIBE-
CA CV LICHEN

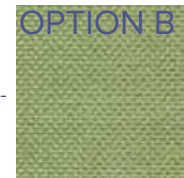

MAGILE ECOSEN-
SCE SAGE

B WALL ART

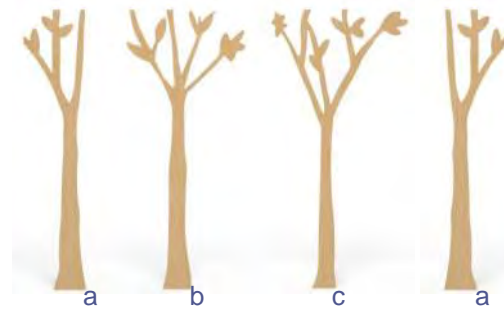

WOOD FINISH

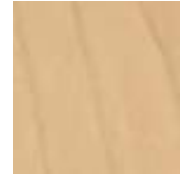

CLEAR

TMC - GROVE TREES
WALL ART
C Tree code WMGT4795
B Tree code WMGT4095
A Tree code WMGT2195

C WALL BENCH

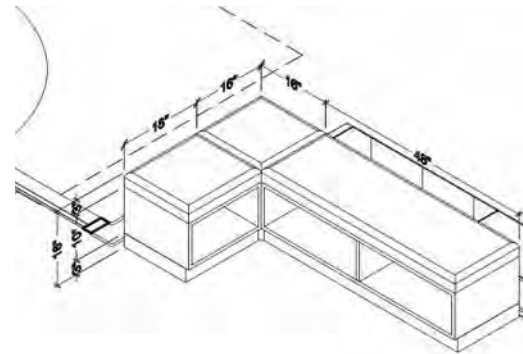

CUSTOM BENCH WITH CUSHION TOP AND STORAGE BELOW
TO BE CUSTOM OR WBMFG

WOOD FINISH



CLEAR

SEAT

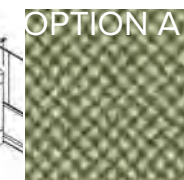

MOMENTUM TRIBE-
CA CV LICHEN

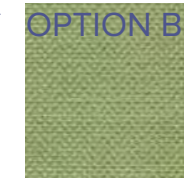

MAGILE ECOSEN-
SCE SAGE

D COMPUTER WORKSTATION



TMC WORKING HABITAT TABLE
24"D X 108"W X 25"H

TOP: LAMINATE



HPL - HIGH RISE

WOOD FINISH

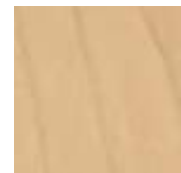

CLEAR

- F *EXISTING CHILDRENS TABLE + CHAIRS
- G *EXISTING LOUNGE
- E +BOOK SEARCH STATION TO MATCH STACKS

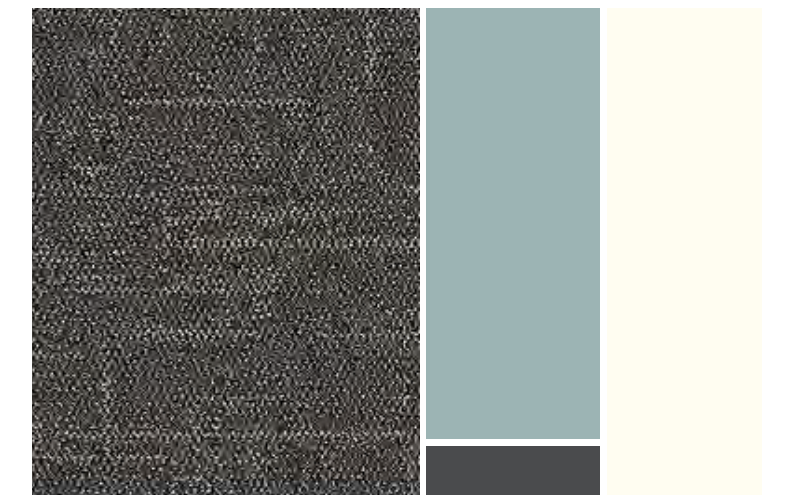
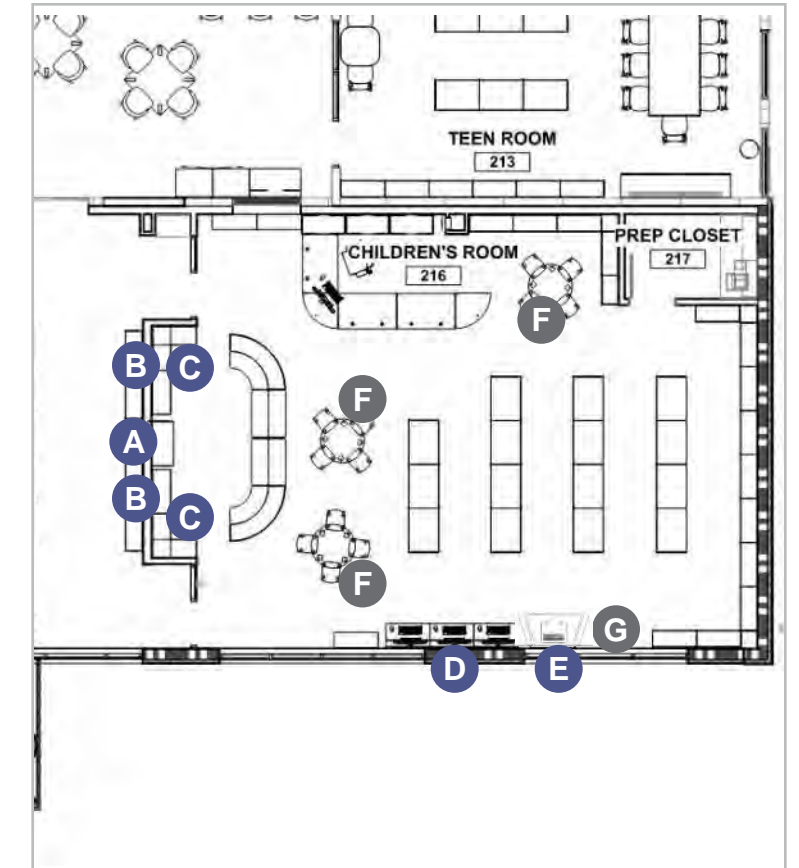

CHILDREN'S ROOM

GROUP OTTOMANS



NORVA NIVEL AMPHI JR .3
EASY CONFIGURE FOR SEATING OR SURFACE
High Bench 129" x 14" x 18"H
Low Bench 129" x 14" x 12" H

OPTION A



OPTION B

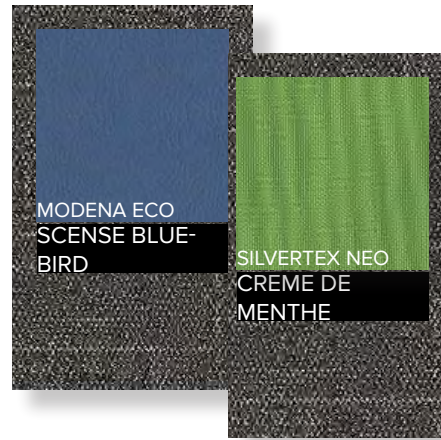

OTTOMANS

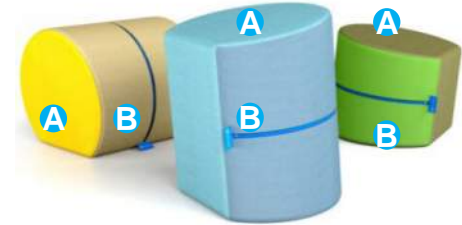

NORVANIVEL ROCKER OTTS .10
14" SEAT HEIGHT



- F** *EXISTING CHILDRENS TABLE + CHAIRS
- G** *EXISTING LOUNGE
- E** +BOOK SEARCH STATION TO MATCH STACKS

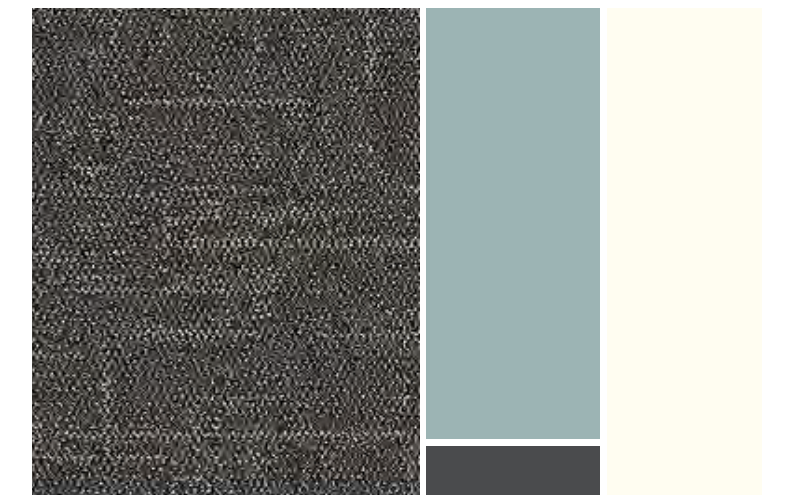
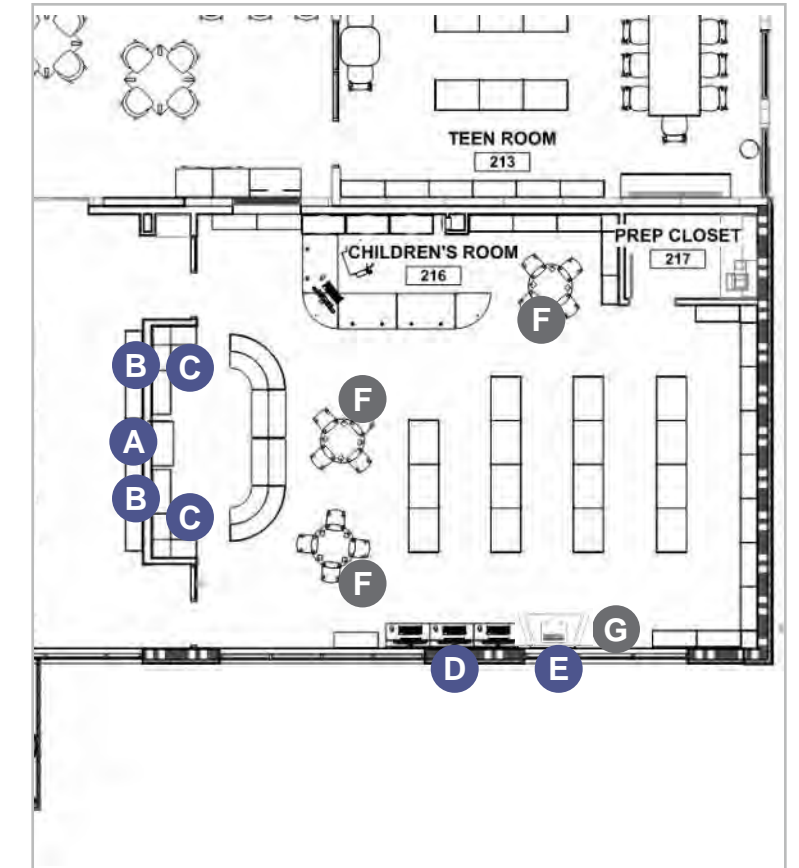

OUTDOOR READING

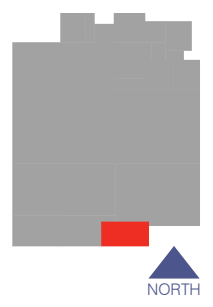

WOVEN BAND

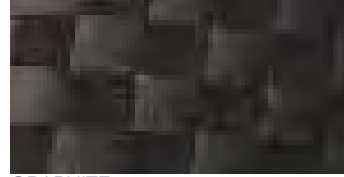

GRAPHITE

SEAT



ANDREU WORLD TRACK ONE REF. 2444

FRAME



EARTH BROWN

A ANDREU WORLD MARINA LOUNGE
DESIGNED FOR OUTDOOR USE
CUSHIONS REPELS WATER, RESISTANT TO
UV RAYS AND MOLD



FRAME



LAVANDER F20

ROPE

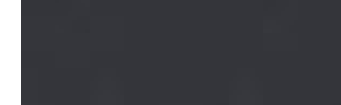

GRAPHITE

SEAT



PARFAIT T115

B AKULA FULHAM 2 SEAT SOFA
DESIGNED FOR OUTDOOR USE



METAL



YELLOW 6

C VIA AMALFI CHAIR
19.7" W
DESIGNED FOR EXTREME HEAT, HUMIDITY &
SALT WATER AIR

D VIA SIERRA 015 COLLECTION
39.4" ROUND
DESIGNED FOR EXTREME HEAT, HUMIDITY &
SALT WATER AIR



E BLUEDOT HUNKY DORY TALL
WHITE TERAZZO

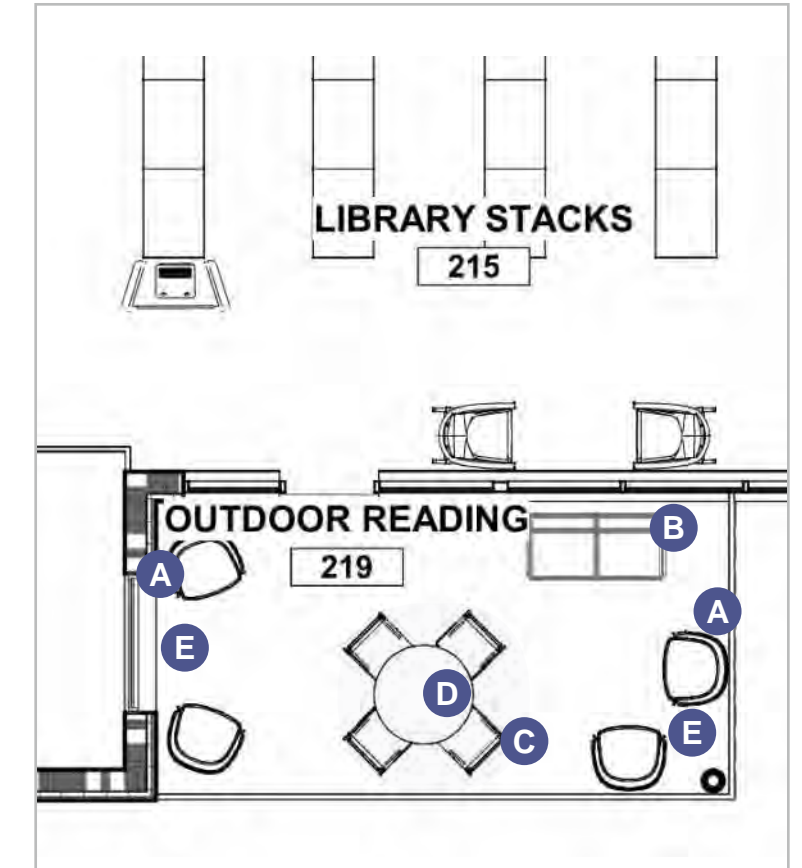

WORKSTATION 1

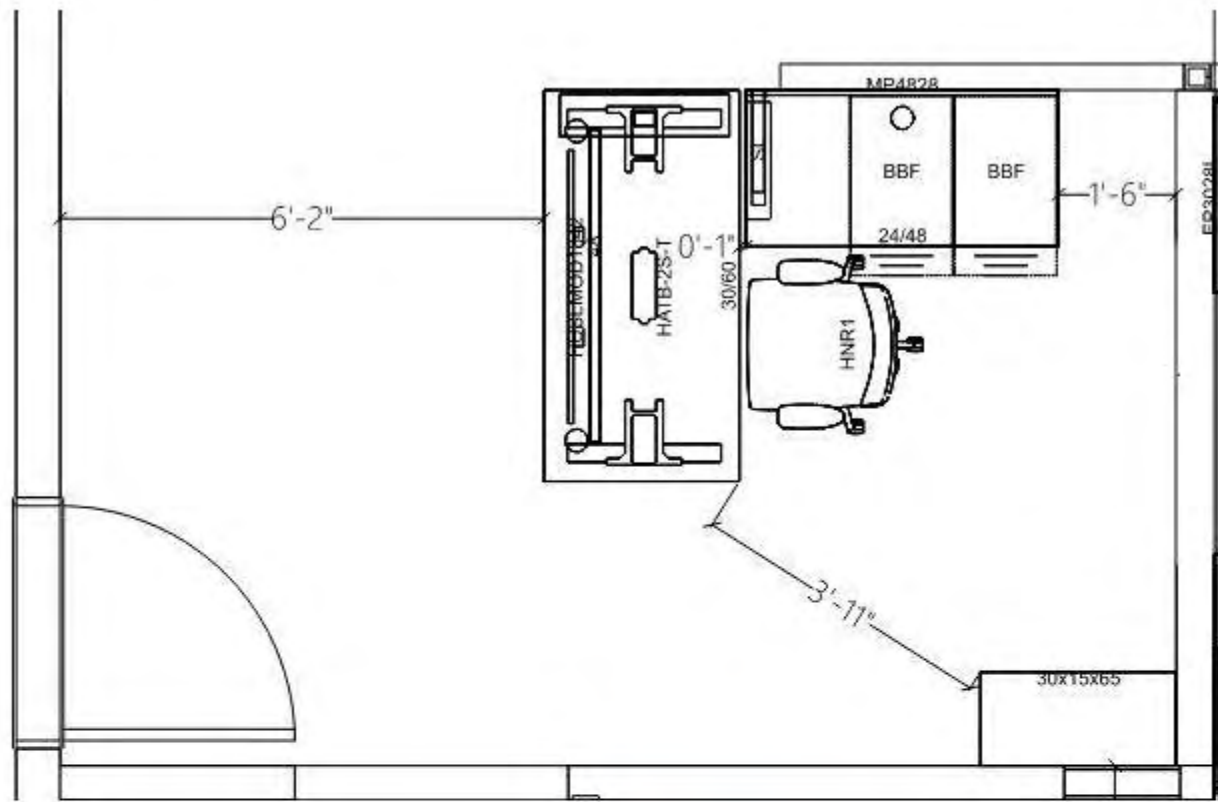

LAMINATE

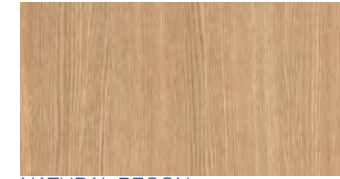

NATURAL RECON

PULLS



SILVER

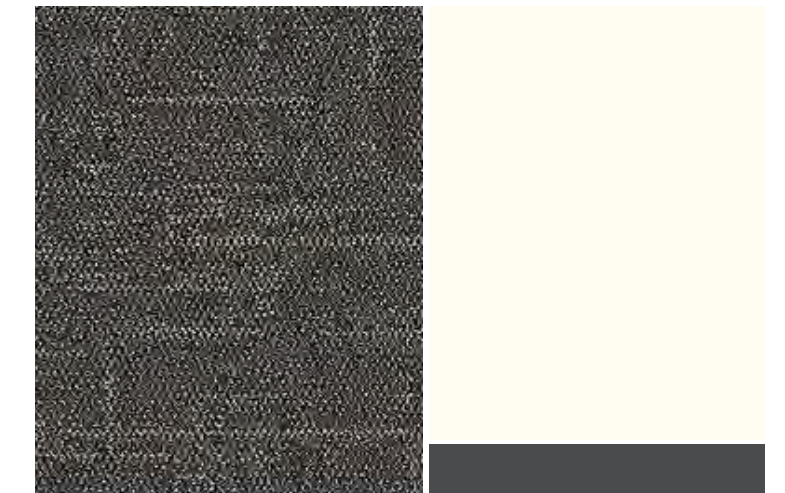
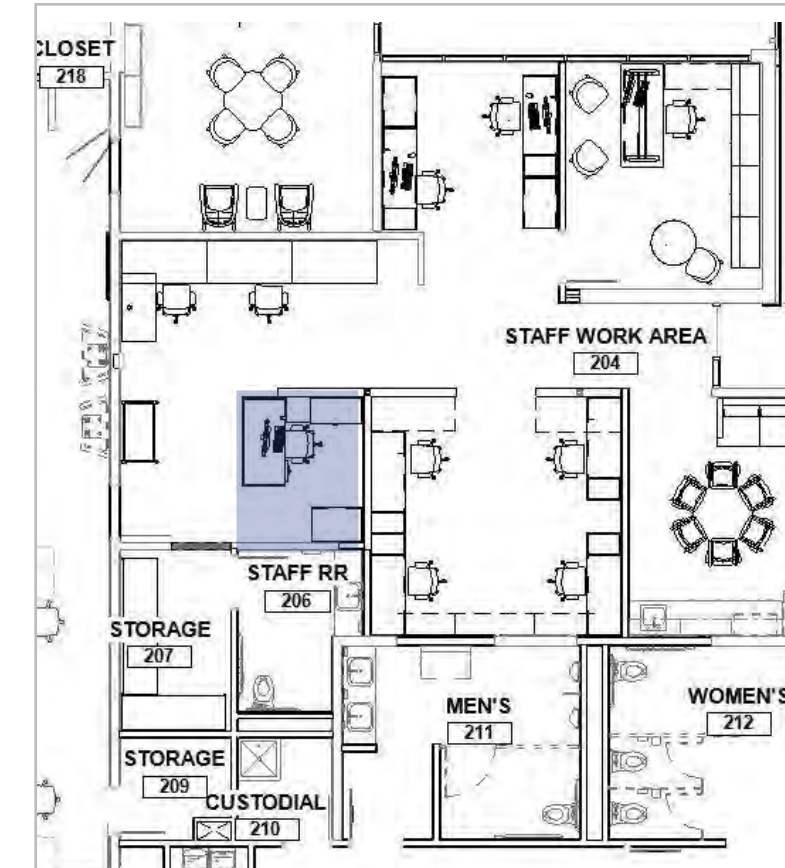

WORKSTATION 2

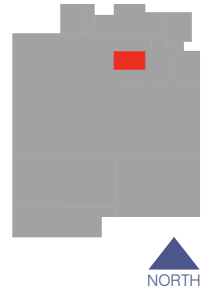

A CUSTOM WORKSTATION

- COUNTER HEIGHT WORKSURFACE
- STORAGE DRAWER & CABINETS BELOW
- OVERHEAD ADJUSTABLE SHELF'S
LOAD BERARING FOR BOOK STORAGE
- UNDER CABINET LIGHT

LAMINATE

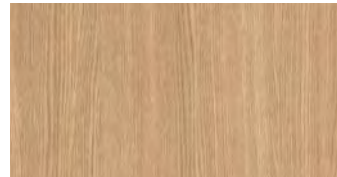

NATURAL RECON

PULLS



SILVER

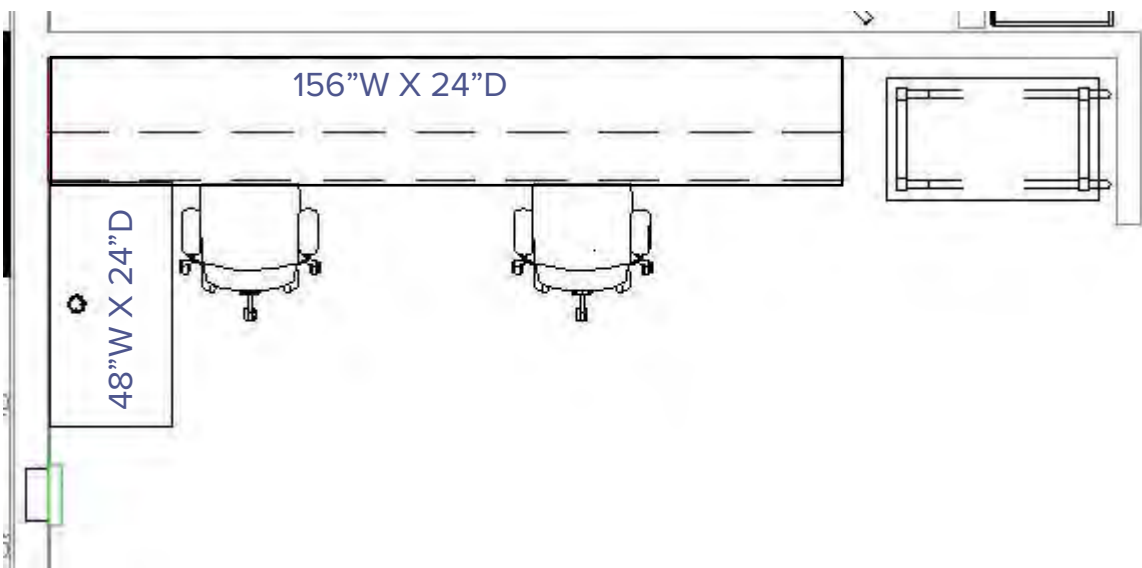

B



ULINE WELDED STEELFLAT SHELF CART
FOR HEAVY OVERSIZED ITEMS
2 SHELF CART 1200LB WC
H-3037 - 42 X 24 X 35

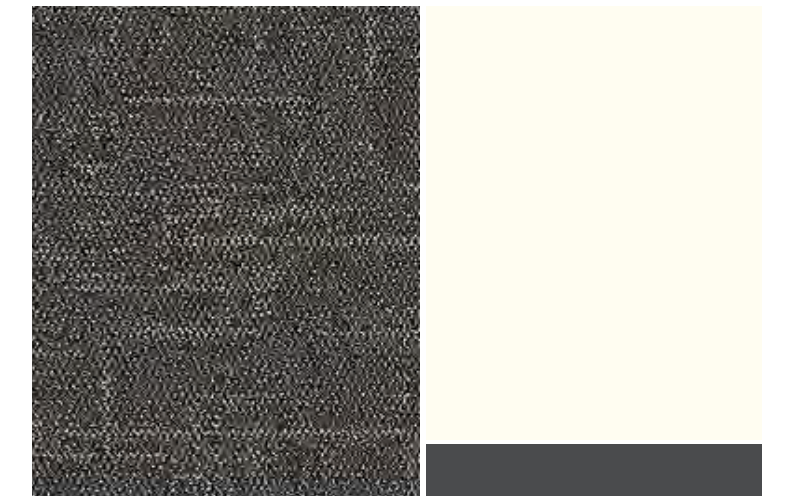
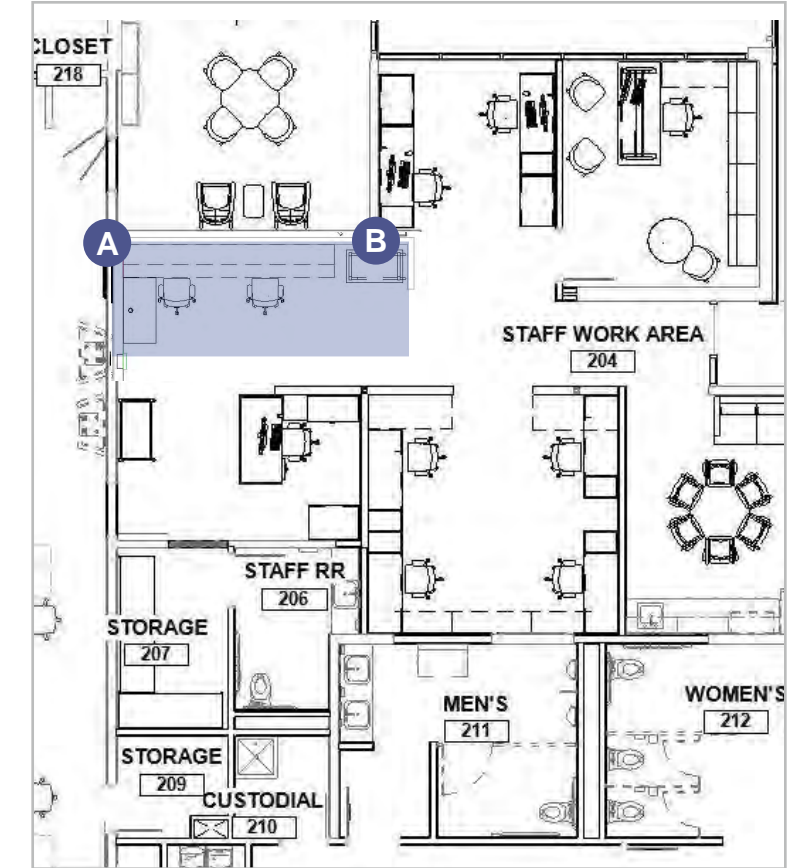

WORKSTATION 3

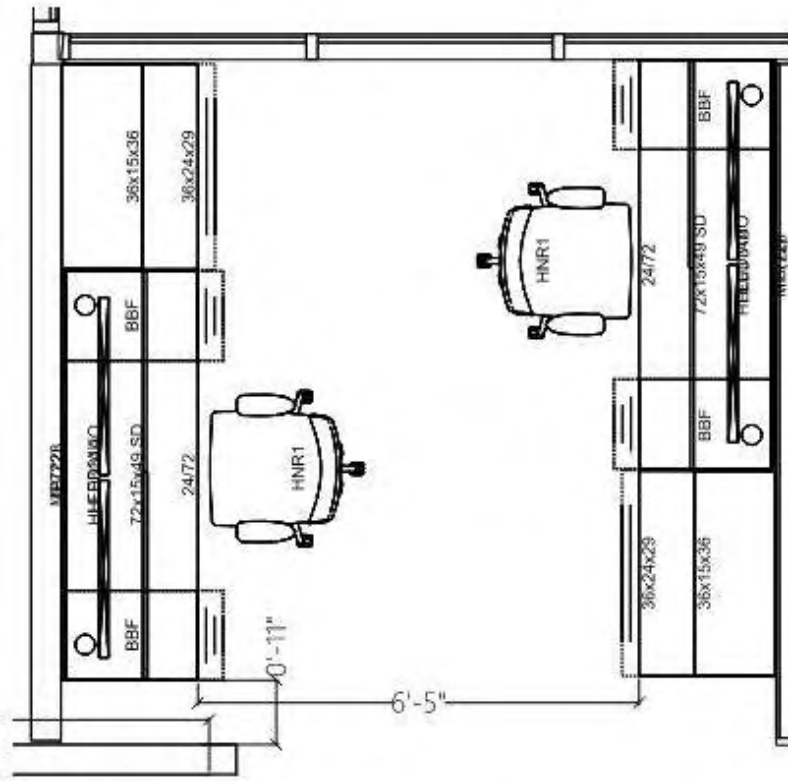
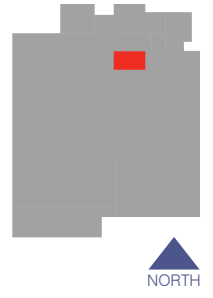

LAMINATE

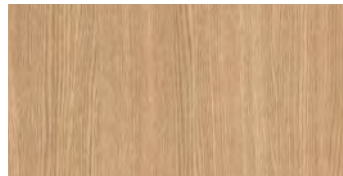

NATURAL RECON

PULLS



SILVER

TACKBOARD



VAST VINEYARD
VST01

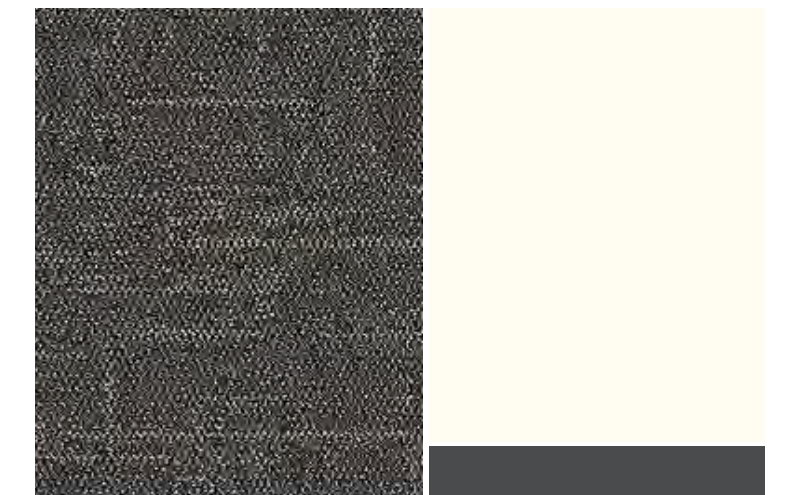
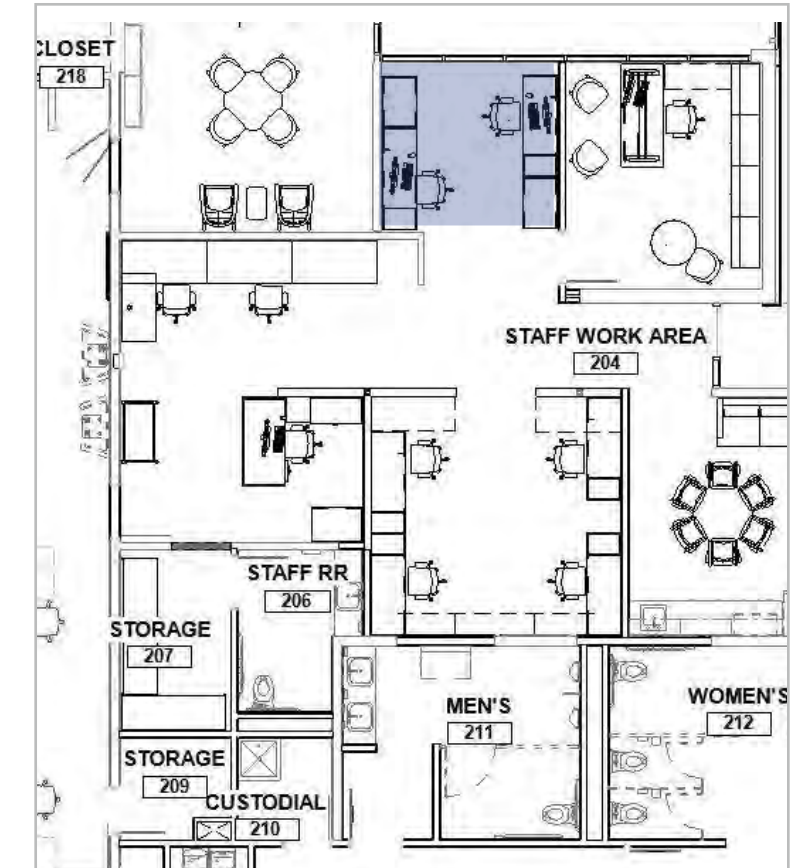

WORKSTATION 4

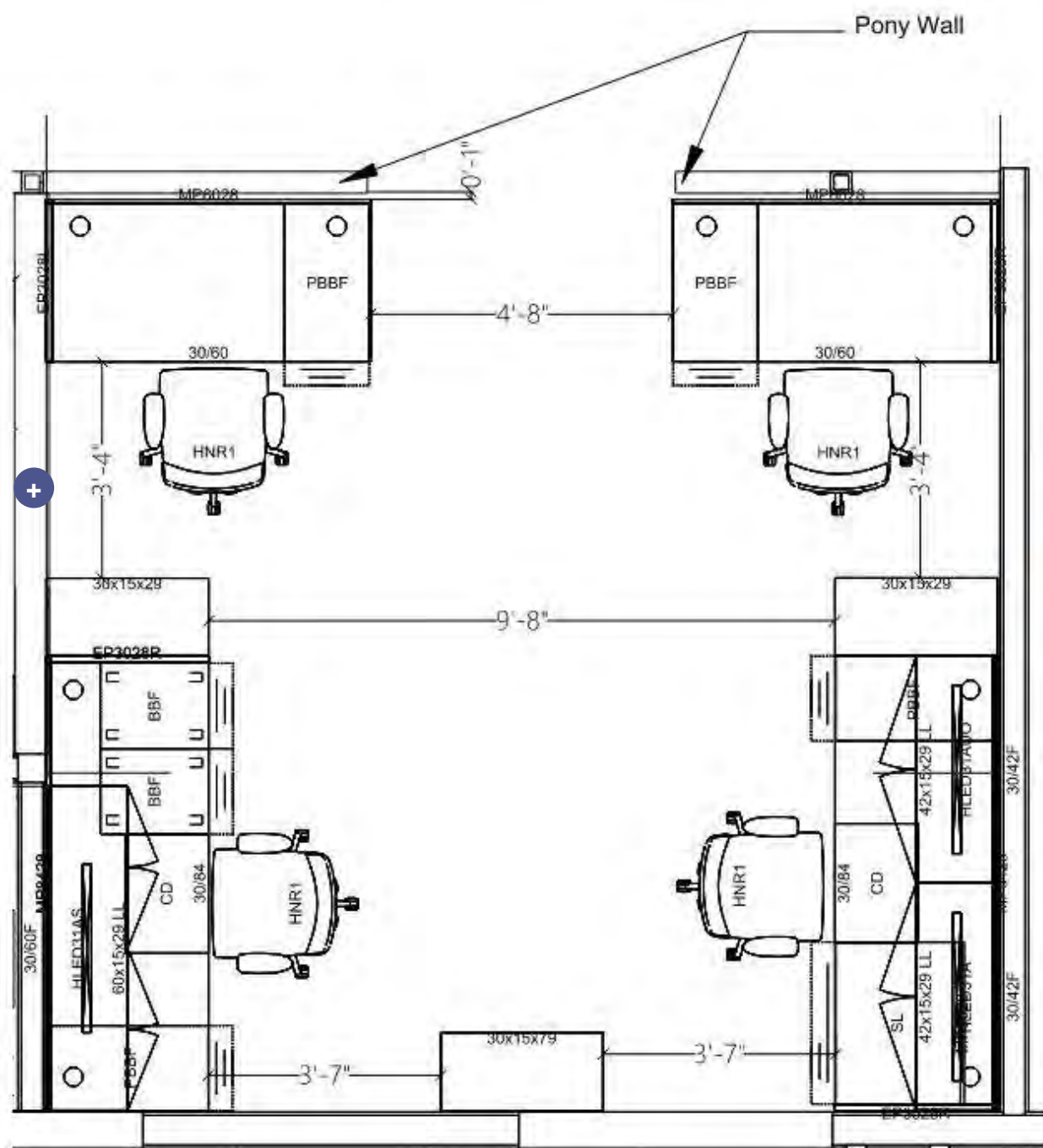
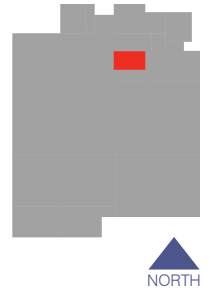

Note :-

- 29"H wall mount storage is available with door only. Dealer to verify prior to order.
- As per the request we have specified the overhead storage at the height of 60" from ground, thus, we have specified 30"H tackboard to cover the entire gap between table top and overhead storage. Dealer to verify prior to order.

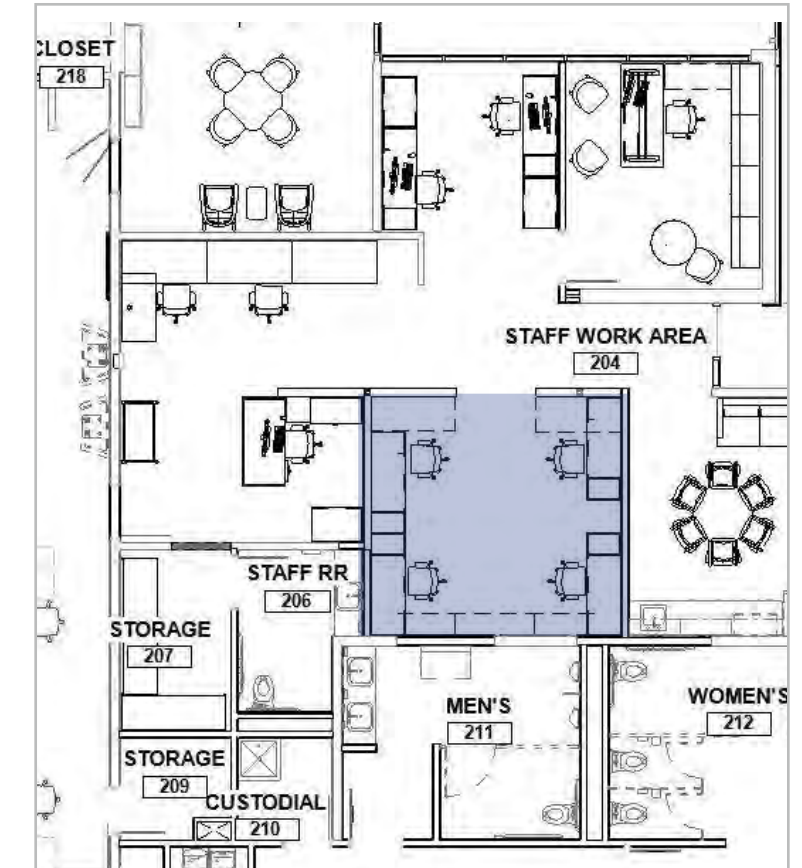

LAMINATE

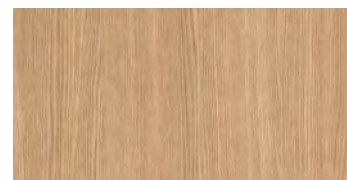

NATURAL RECON

PULLS



SILVER

TACKBOARD



VAST VINEYARD VST01



HON - UNIVERSAL SCREEN
(2) 30"W X 20"H ACRYLIC SCREENS
(1) 36"W X 20"H ACRYLIC SCREENS
90 DEGREE ANGLE EDGE

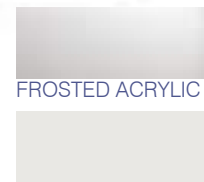

FROSTED ACRYLIC

HARDWARE: LIGHT GREY

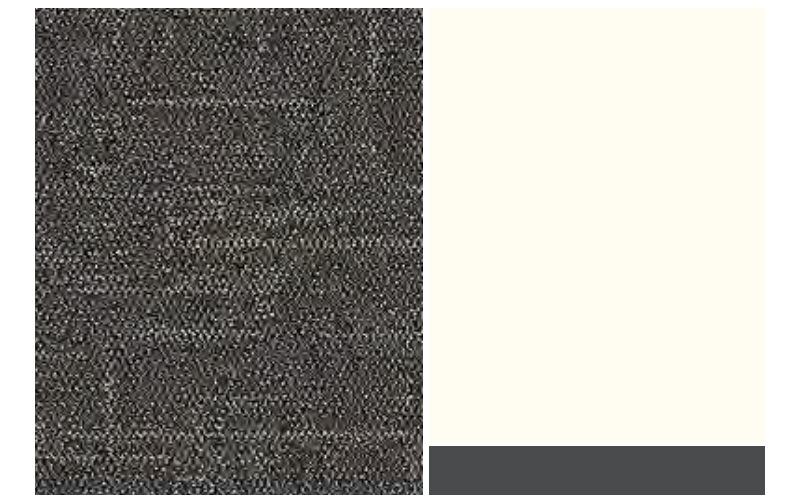

WORKSTATION 5

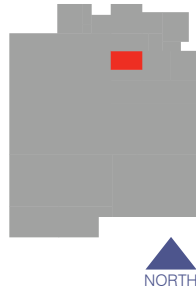

LAYOUT

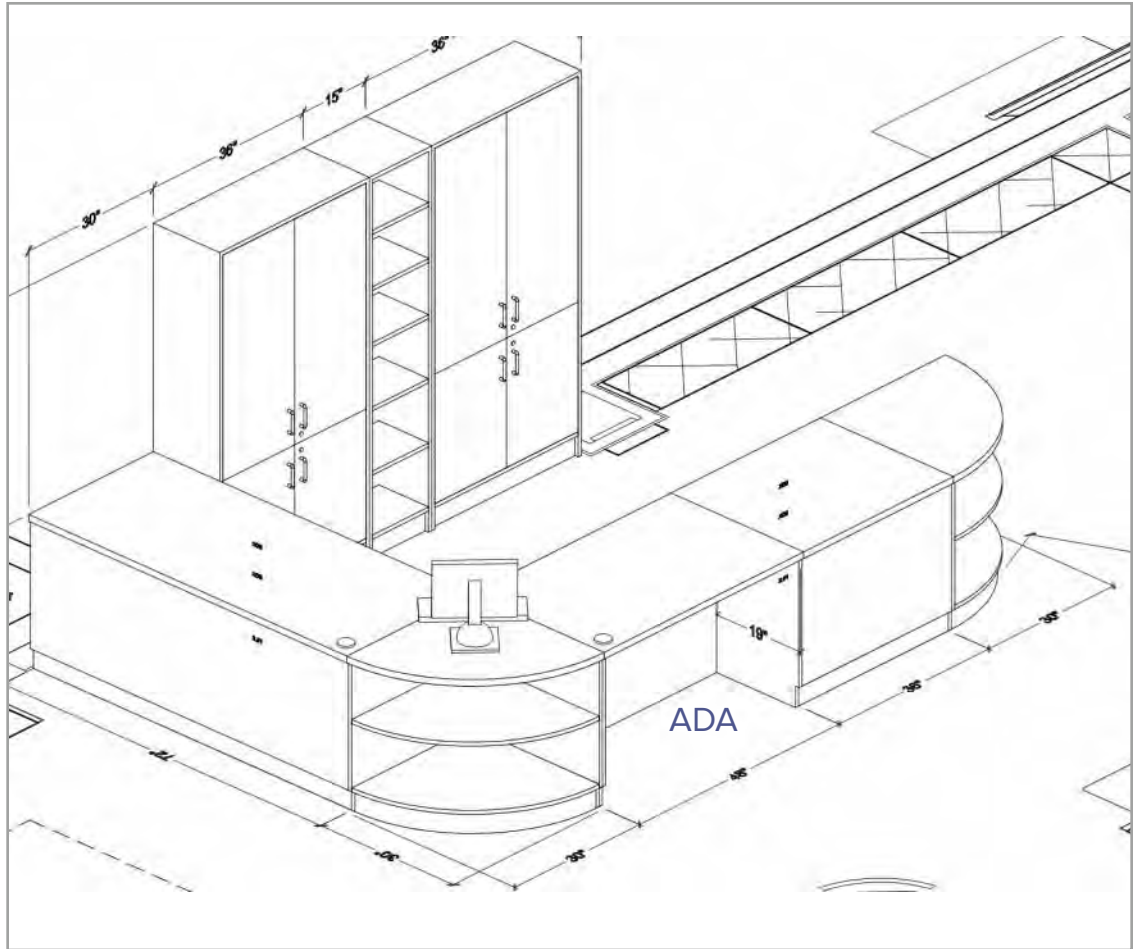

CASEWORK

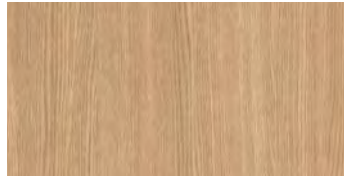

NATURAL RIFT

PULLS



SILVER

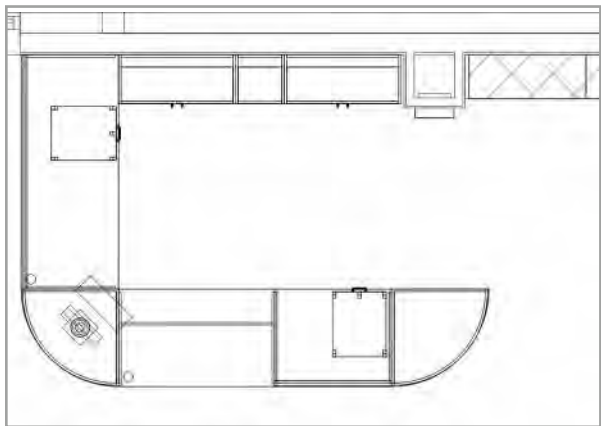

FLOOR PLAN LAYOUT

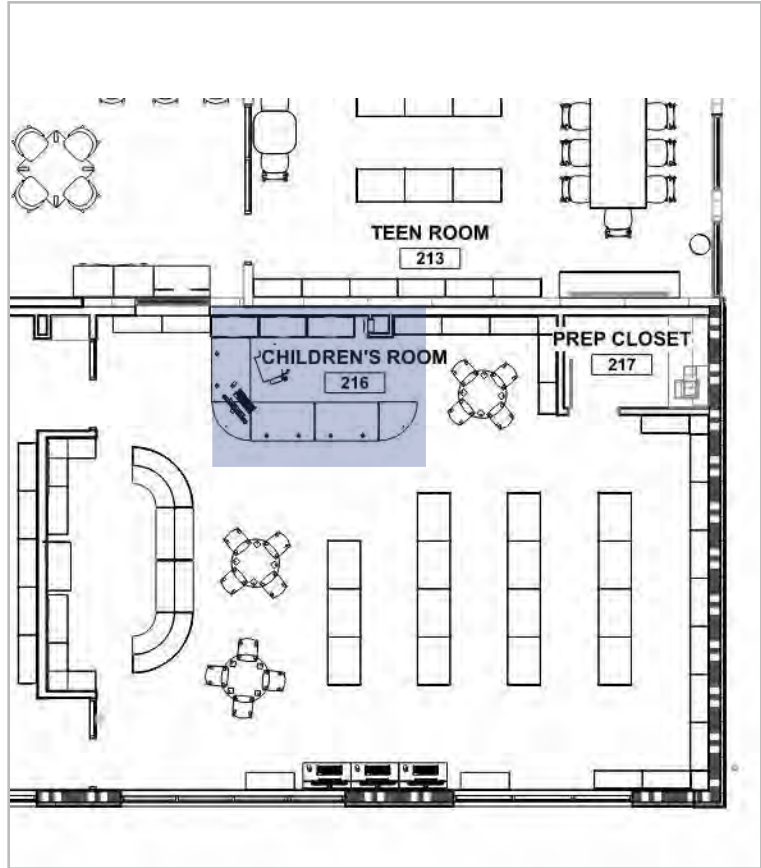

PRIVATE OFFICE

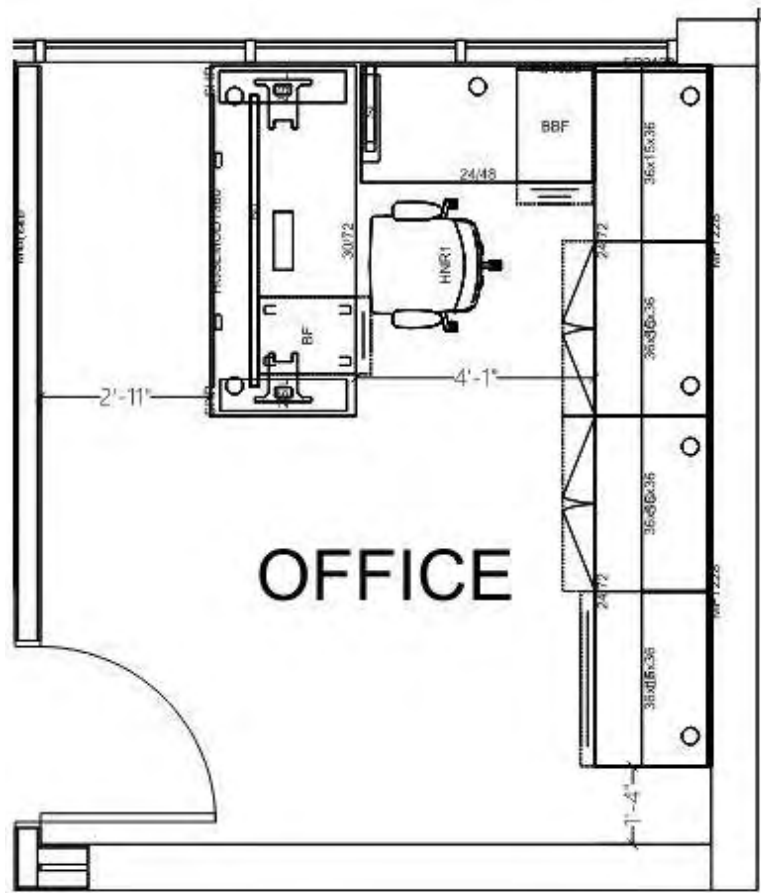

ECLIPSE CHAIR

MADE IN NEVADA STACKS 15H
WC: 300LBS, 12YR WARRANTY

SHELL



DUSTY ROSE

FRAME



BLACK



HON BETWEEN ROUND TABLE
30" ROUND

LAMINATE



NATURAL RECON

BASE



BLACK

LAMINATE

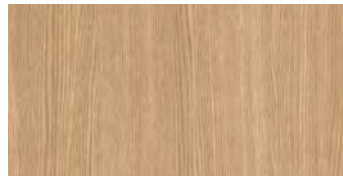

NATURAL RECON

PULLS



SILVER

TACKBOARD



VAST VINEYARD
VST01

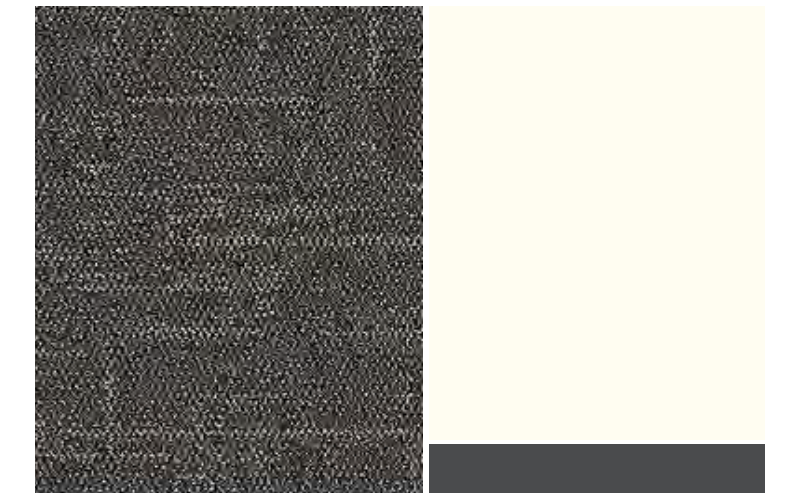
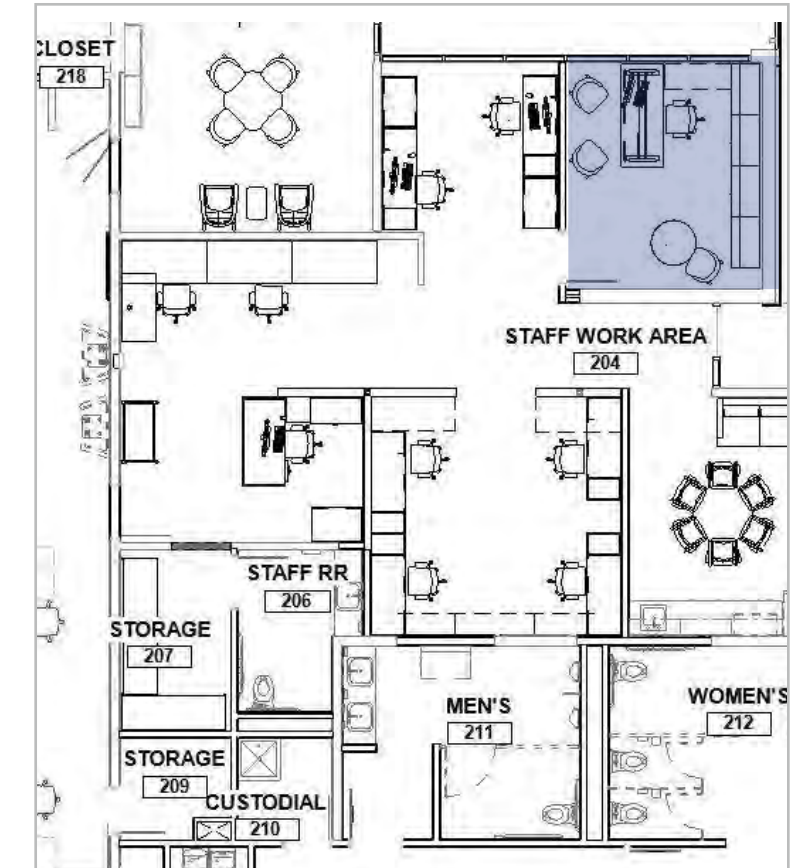
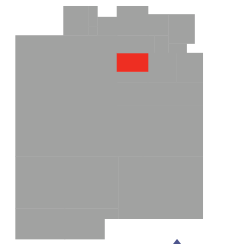

BREAK ROOM

A TABLE



JSI NOSH ROUNDED RECTANGLE
WITH ROUNDED DISC BASE
36X72

LAMINATE



BLACK

BASE



BLACK

B SEATING OPTION



ECLIPSE CHAIR

MADE IN NEVADA STACKS 15H
WC: 300LBS, 12YR WARRANTY

SHELL



DUSTY ROSE

FRAME



BLACK

C LOUNGE SEATING



SABLE SETTE
HIDDEN CLEAN OUT, STEEL LEGS WITH
WOOD GRAIN FINISH
WC 600LB, 12YR WARRANTY

FULLY UPH



MOMENTUM WILLA
BRINDLE

BASE



BLACK

D LOCKER TO BE EXISTING

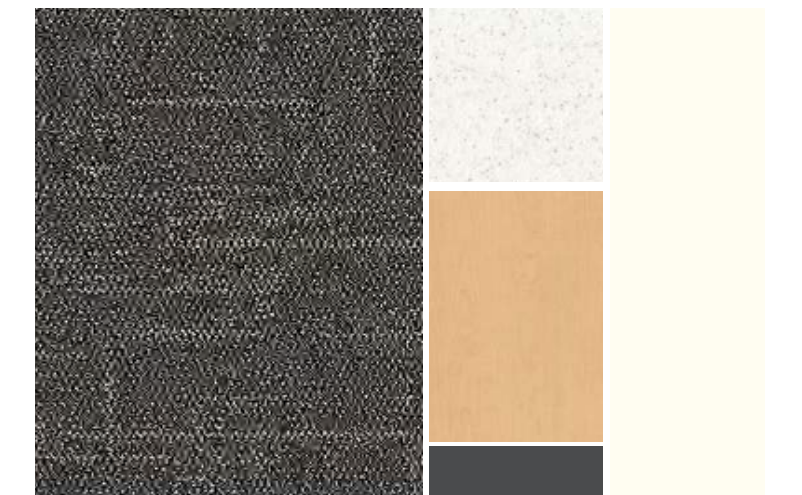
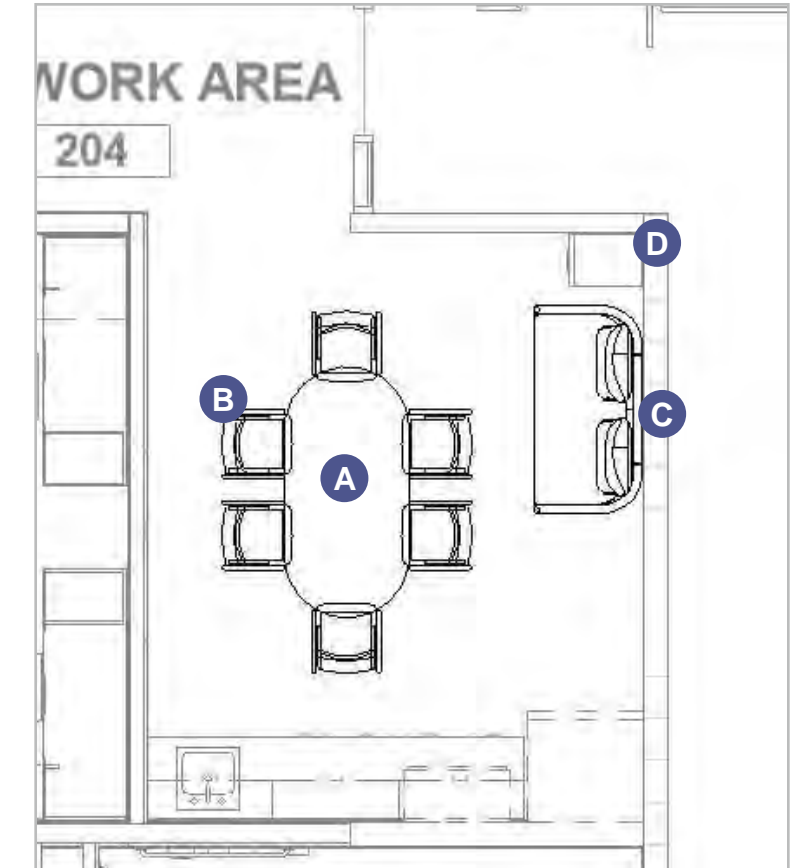

LOWER LEVEL ENTRY

INFORMATION DESK

A



WB MFG. MOBILE CURVED CIR DESK
+ LOCKABLE STORAGE

B



MOBILE STORAGE

C



WB MFG. DRAWER OVER DOUBLE DOOR
BASE CABINETS + CASTERS
+ LOCKABLE STORAGE

CASEWORK

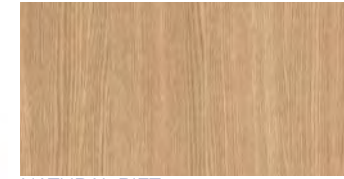

NATURAL RIFT

PULLS



SILVER

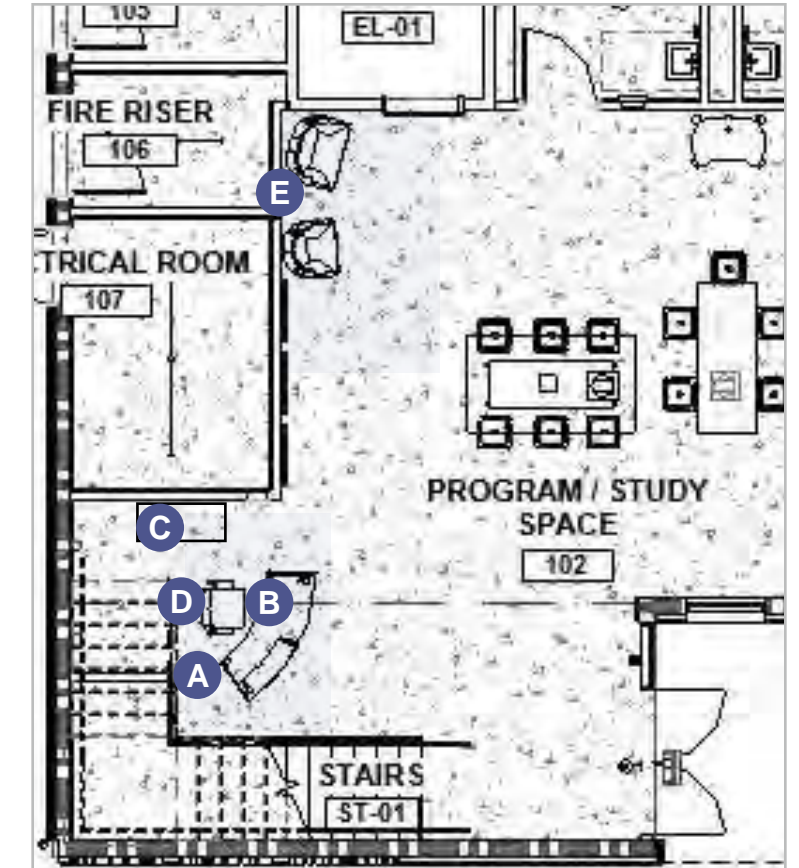

FULLY UPHOLSTERED



MOMENTUM SILICA SUEDE
INDIGO

FRAME



LIGHT WALNUT

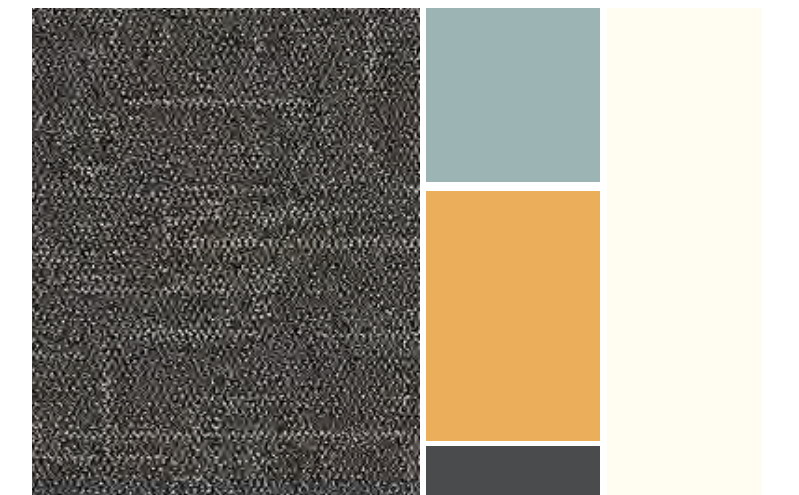

D

HUMANSCALE - FREEDOM

ERGONOMIC & WEIGHT SENSITIVE RECLINE AND SYN-
CHRONOUSLY ADJUSTABLE ARMRESTS
WC 400LB, 15YR WARRANTY

E



KWALU MONTEDORO B. LOUNGE
30"W SEAT, 525LB W.C.
CONCEALED CLEAN OUT

LOWER LEVEL MAKER SPACE

MAKER SPACE TABLE + STOOLS

B



CEF HIDEAWAY STORAGE TABLE
34"H X 40"W X 90"L
POWER 2 USB AND 2 AC + LOCKABLE

D



CEF CHAMELEON ADA
30"D X 60"W X 34"H

TOP



BUTCHER BLOCK

LAMINATE



CONCORD GRAPE

METAL



SILVER

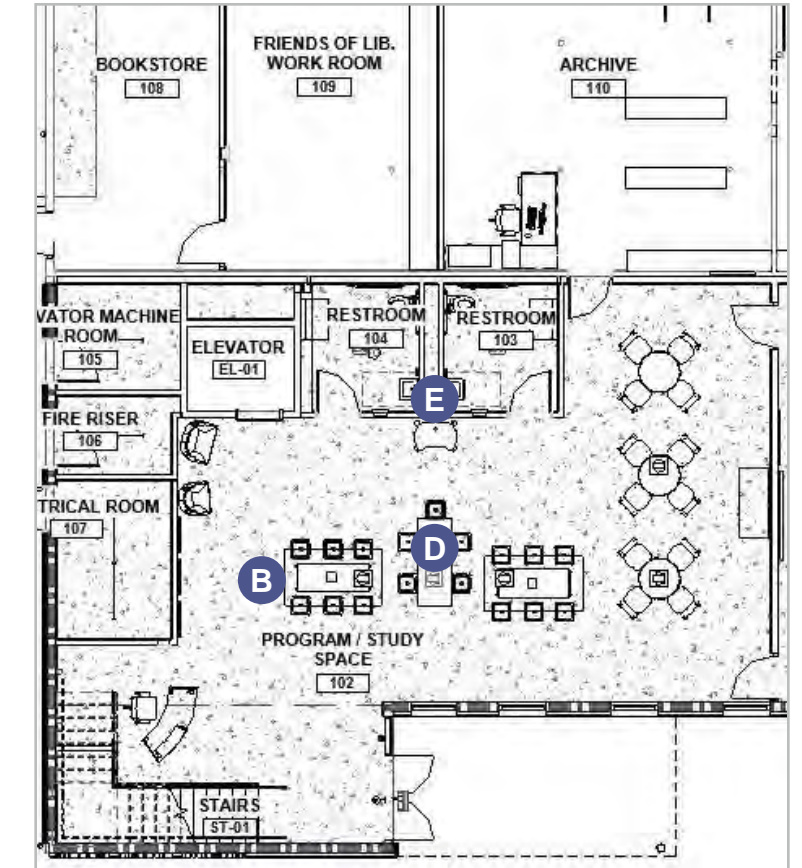

MAKER SPACE STORAGE

E



WB MFG CUSTOM
COMBINING PRINTER CART & STORAGE CABINET ON CASTERS (NO BAR FOR SPOOL)
48"W X X72"H X 22"D

CASEWORK

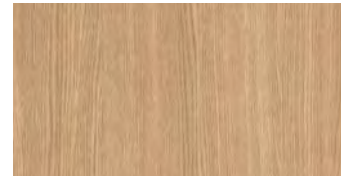

NATURAL RIFT

PULLS



SILVER

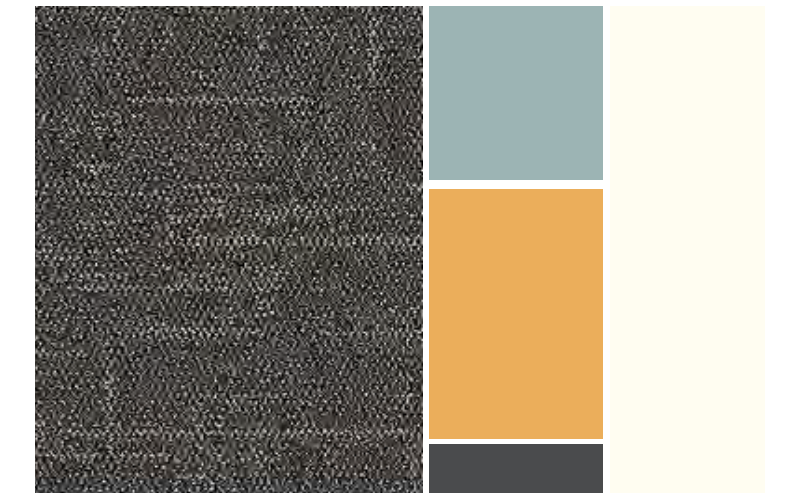

LOWER LEVEL

A MOBILE TABLE



SICO SOCIALIZER
MOBILE FLIP NEST TABLE 36"

LAMINATE

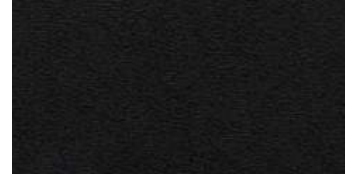

BLACK

METAL



BLACK

B SEATING



SIT ON IT SEATING MIKA

SHELL



FOG

FRAME



SILVER

C DISPLAY CASE



GAYLORD ARCHIVAL
30"H PEDESTAL 20"HX60"WX30"D

archival-quality base and deck will not off-gas, protecting the objects on display. Available with a standard or UV-filtering acrylic vitrine that secures to the base with security screws to prevent tampering and damage.

ALTERNATE



DISPLAY 2 GO DISPLAY CASE
LOCKABLE, TEMPERED GLASS, LED LIGHT

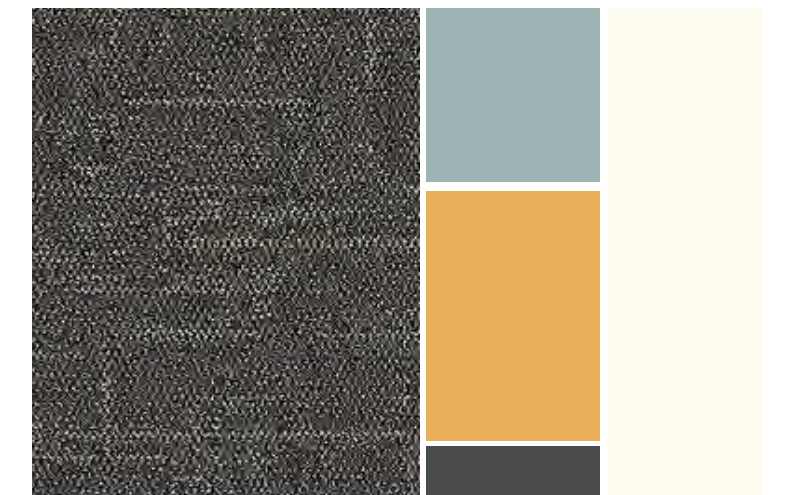
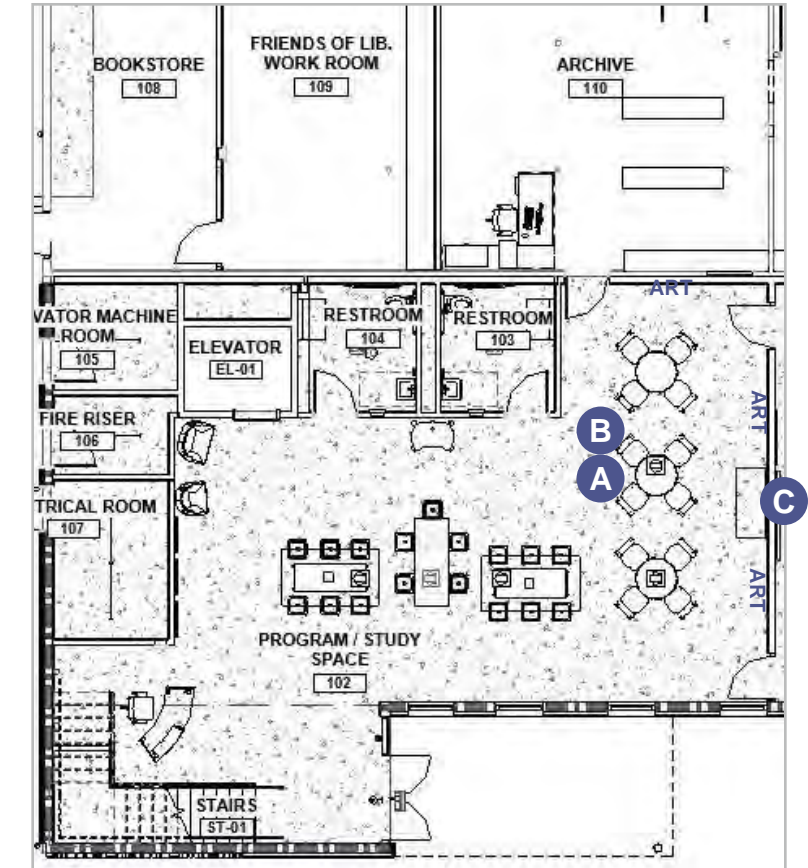

COMMUNITY MEETING ROOM

A STACKING



VIA ALL WAYS STACKING / NESTING CHAIR
 ALL POLY CHAIRS (STACK 20H, 300LB WC)
 + GANGING BRACKETS
 QTY. 40 ARMS QTY. 40 NO ARMS
 QTY. 4 CARTS

SHELL



BLACK

FRAME + CASTER



BLACK



B FLIP NEST TABLE



JSI LOKI IN LINE T BASE
 FLIP NEST TABLE 24X66
 QTY. 11

HPL LAMINATE

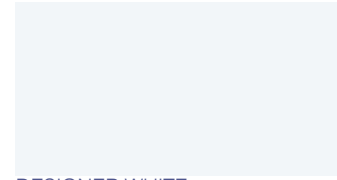

DESIGNER WHITE

METAL



SILVER

C PODIUM

OPTION 1



VENNER



BLACK

METAL



BLACK

NUCRAFT SUMMIT LECTERN
 ADA, ADJUSTABLE HEIGHT HIDDEN CASTERS MICROPHONE OPTION

ALTERNATE OPTION



LAMINATE

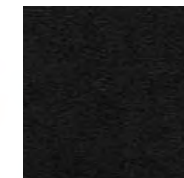

BLACK

METAL



BLACK

JSI NATIVE LECTERN
 MOBILE FIXED HEIGHT

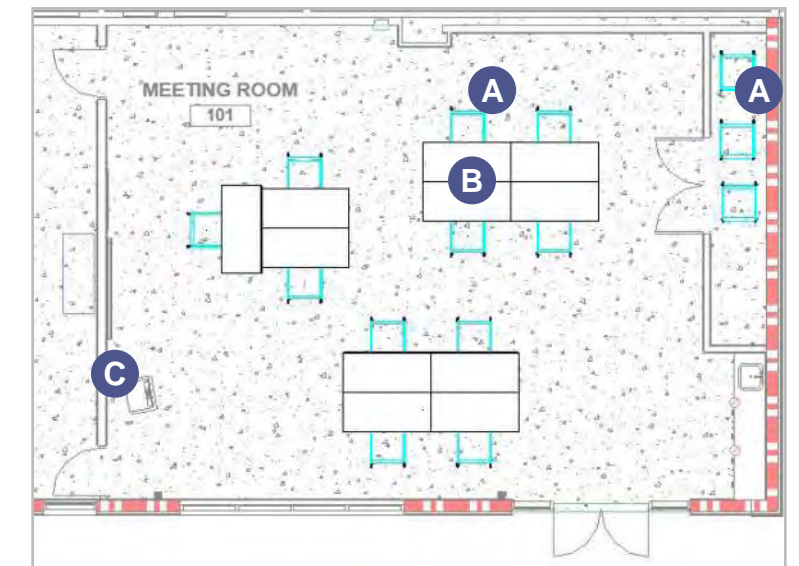
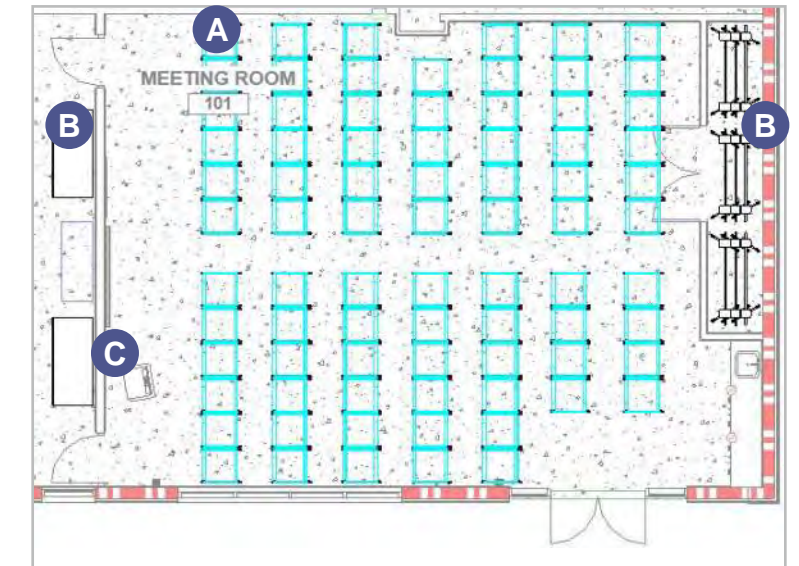
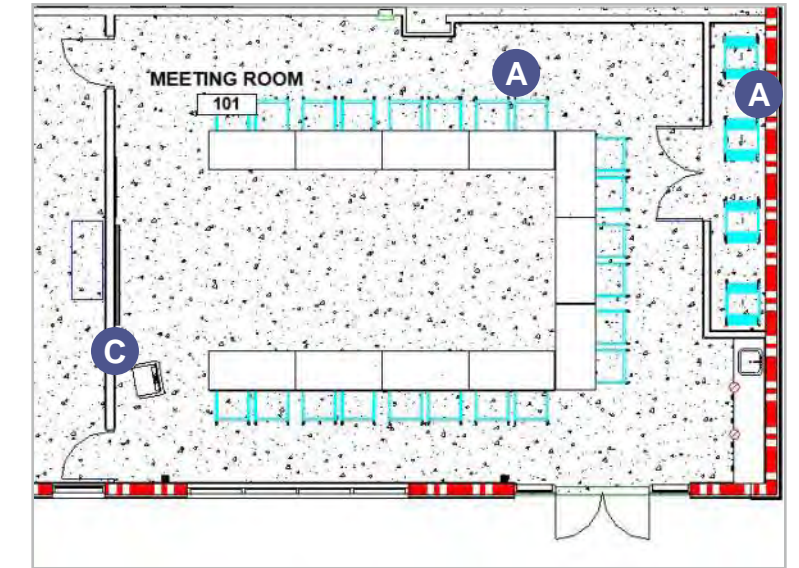

ARCHIVE STORAGE

NEW COMPACT STORAGE

EXISTING CABINETS CAN BE USED

MICROFILM CABINET	36 L X 18 W X 42 H
CABINET A	31 L X 22 W X 53 H (ADMIN FILES)
CABINET B	3 5-DRAWER, STACKED FLAT FILES ON BASE
CABINET C	36 L X 24 W X 72 H
CABINET D	36 L X 24 W X 72 H
CABINET E	36 L X 24 W X 72 H
CABINET F	36 L X 18 W X 72 H
CABINET G	36 L X 18 W X 72 H
CABINET H	36 L X 24 W X 72 H
CABINET I	36 L X 24 W X 72 H



EXISTING TABLE
37"X98"

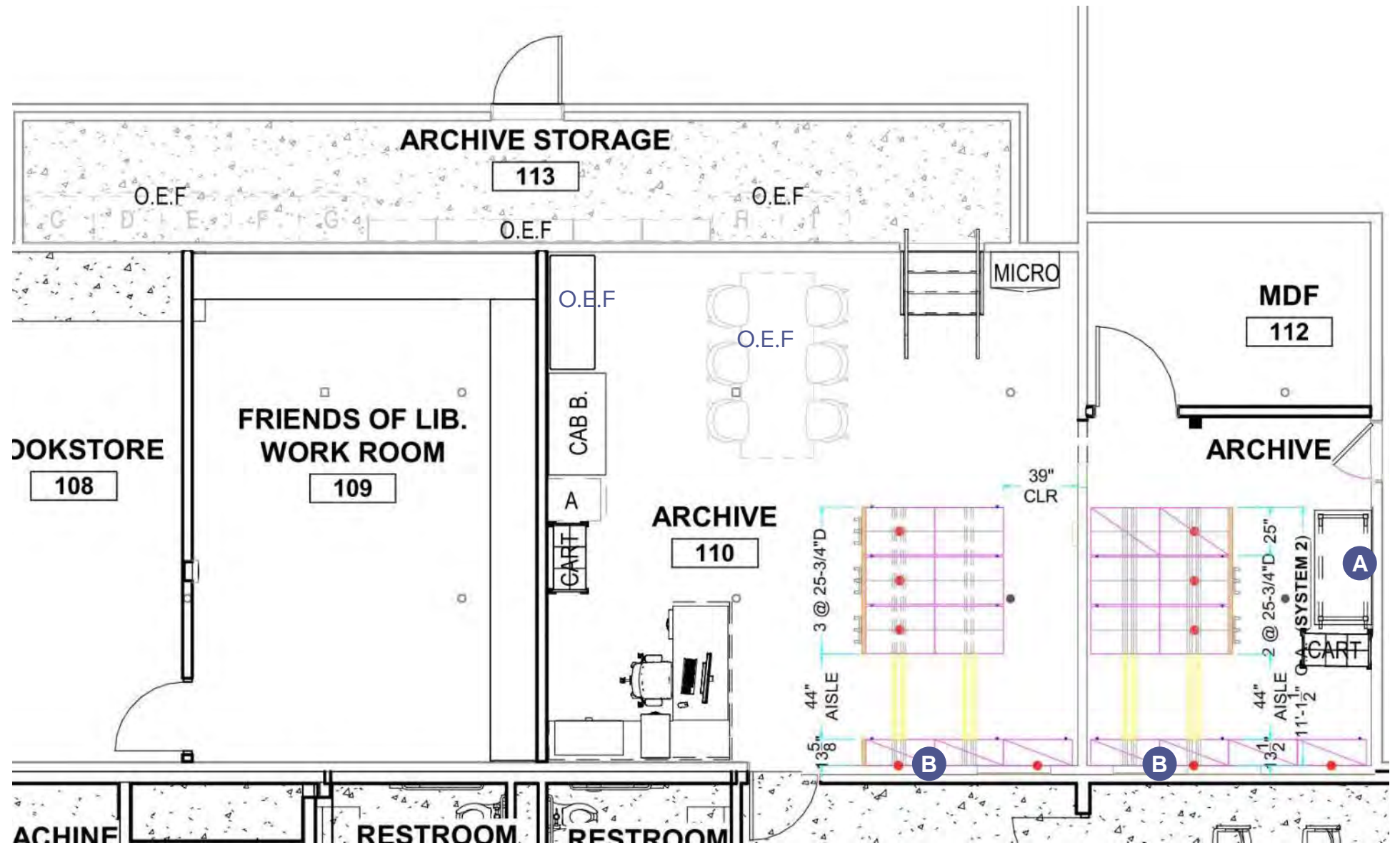

A RECEIVEING TABLE



KI STOUT TABLE 24X60
STEEL TABLE ON CASTERS
BOTTOM SHELF

HPL LAMINATE



BLACK

METAL



ZESTY LIME

B COMPACT SHELF



AURORA



MOONDUST

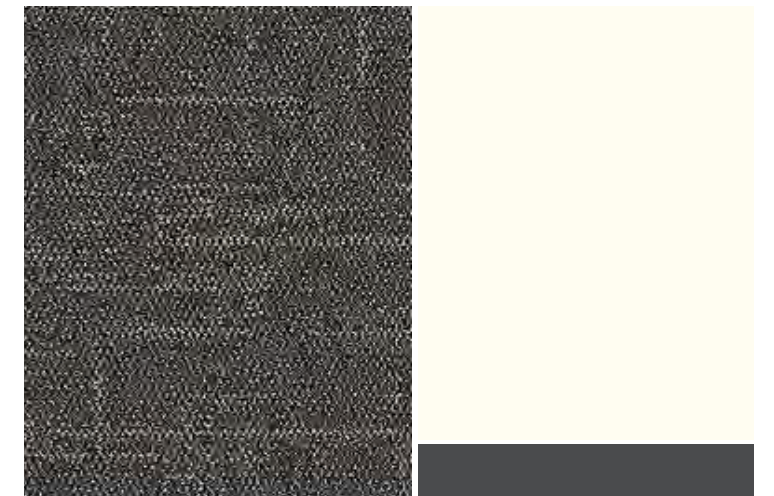

ARCHIVE DESK

WORKSTATION



LAMINATE

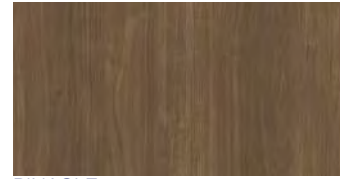

PINACLE

METAL



BLACK

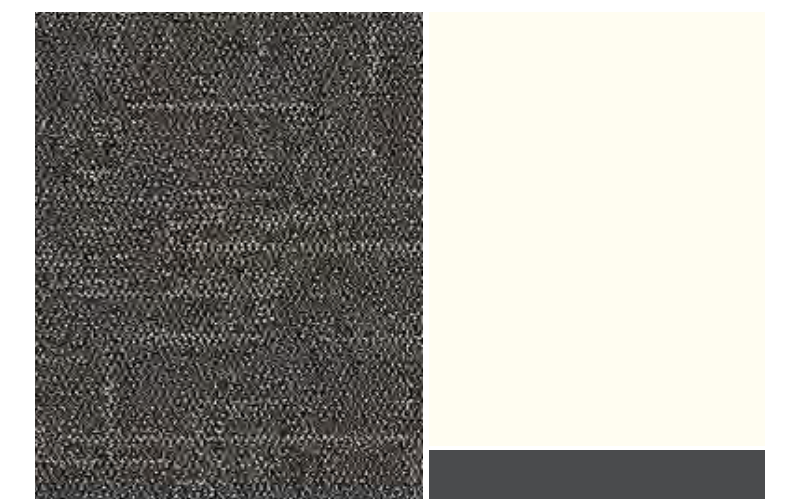
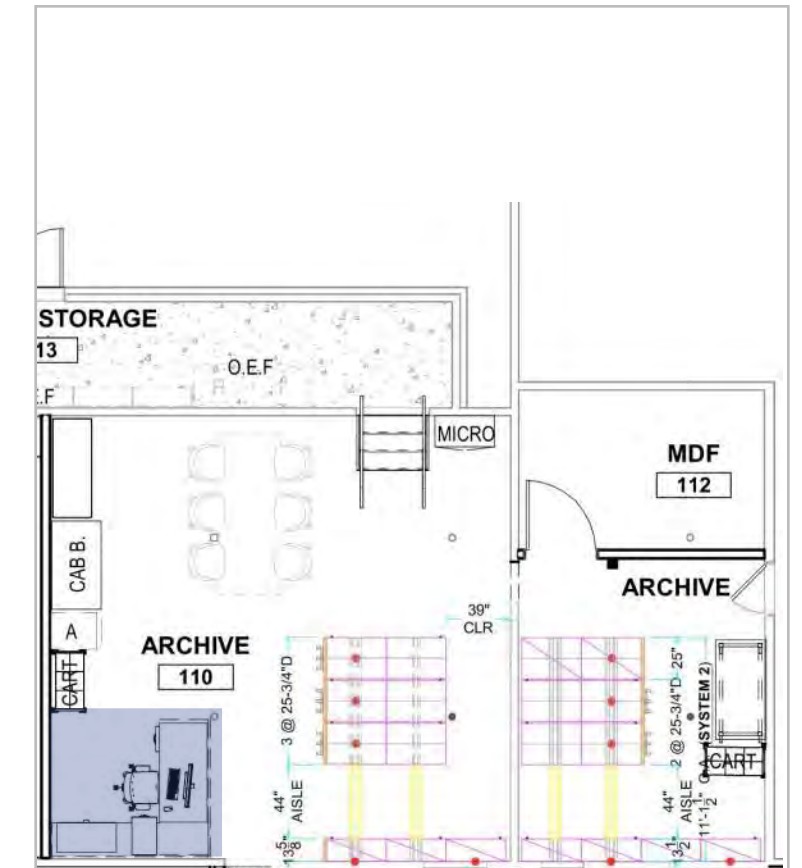
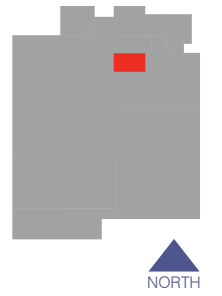

STORAGE

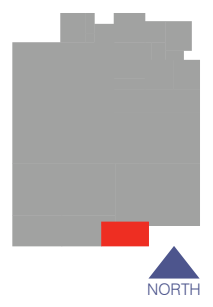

OVERHEAD STORAGE
 LOWER STORAGE WITH HINGED CABINETS
 ONE CABINET TO HAVE NO BOTTOM TO CONCEAL SAFE

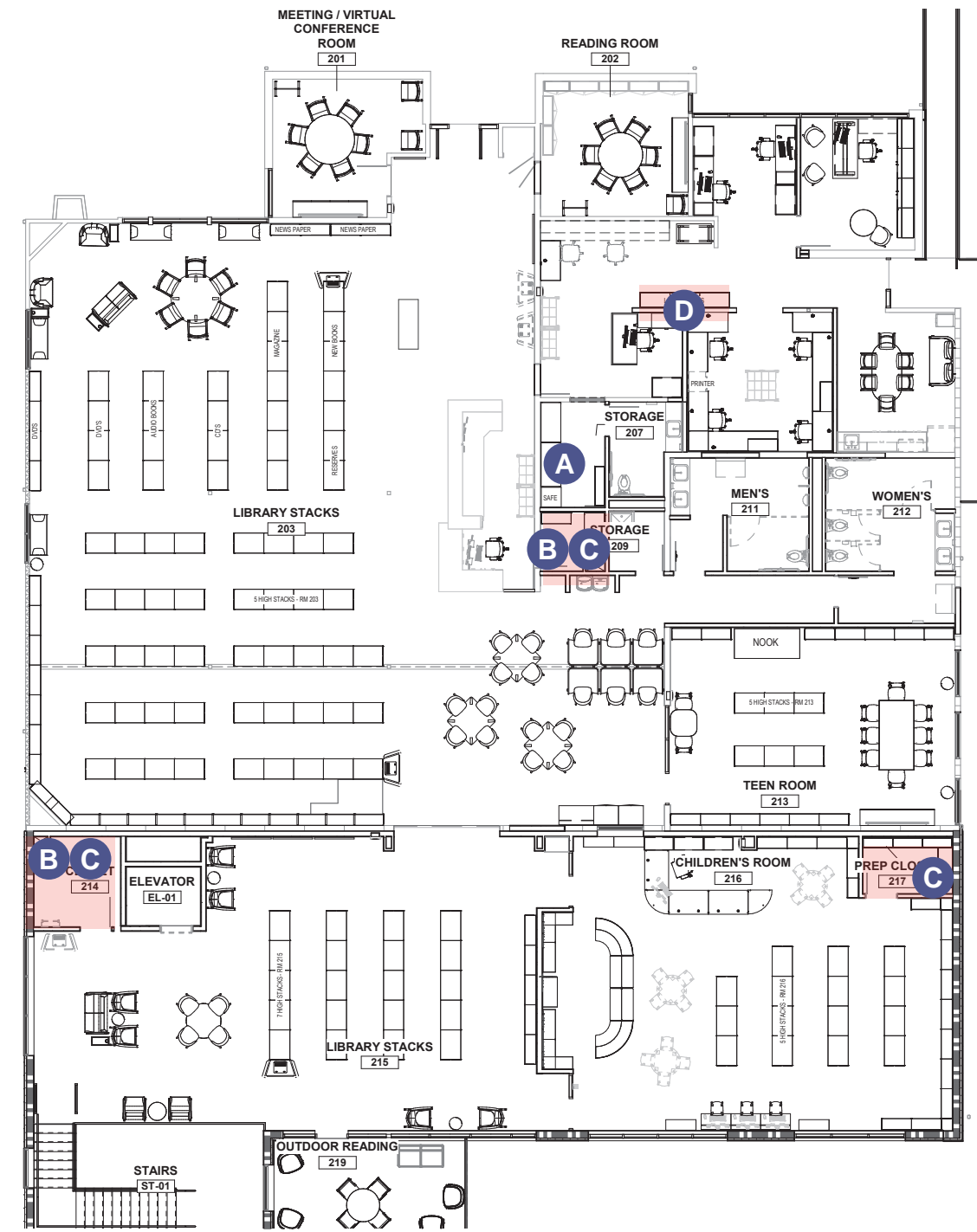
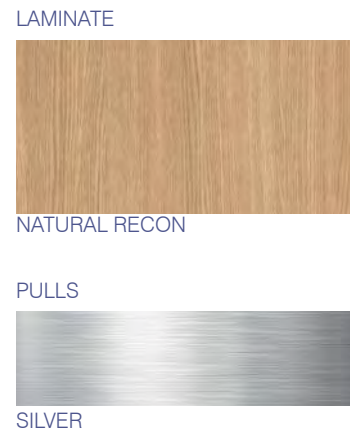

B COMMERCIAL DUTY BOLTELESS SHELVING
 4 SHELVES
 48"W X 24"D X 84"H
 *MAX OUT STORAGE SPACE WITH SHELVING



C WIRE SHELVING + SOLID INSERTS
 4 SHELVES
 36"W X 12"D X 84"H
 *MAX OUT STORAGE SPACE WITH SHELVING



D (3) 3 H LATERAL FILES
 18"D X 36"W
 R-PULL

tsk

316 west second street, penthouse | los angeles, ca 90012 | 702.456.3000 | tska.com